

SURGICAL TECHNIQUE GUIDE

**FREEFIX<sup>®</sup>**

**humeral plating set**

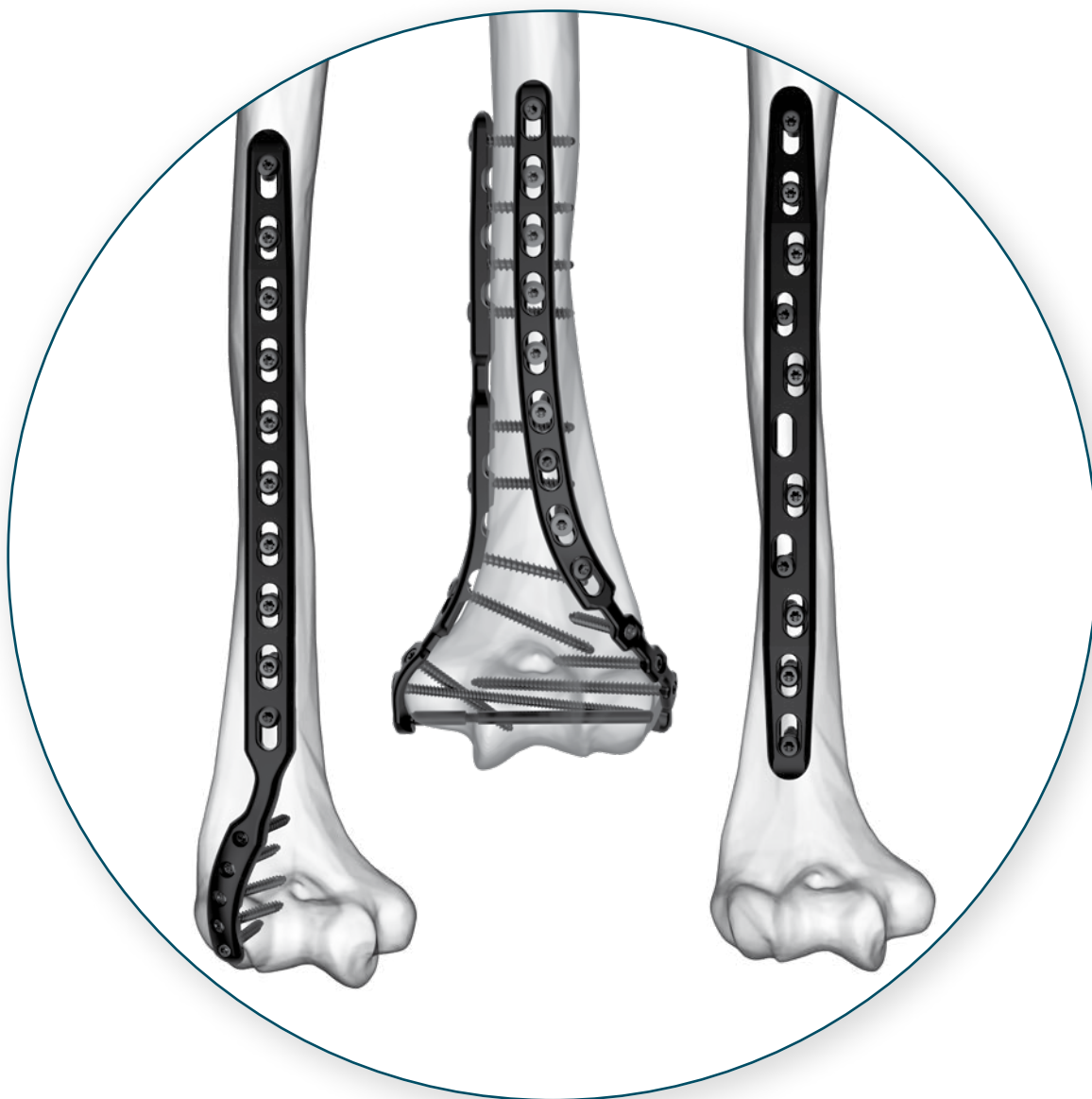

 **skeletal dynamics<sup>®</sup>**  
UNDERSTANDING THE UPPER EXTREMITY

As described by:

Jorge L. Orbay, M.D.

Miami Hand & Upper Extremity Institute



# FREEFIX<sup>®</sup>

## humeral plating set

### Description

The Skeletal Dynamics Humeral Plating Set consists of the following systems:

- Distal Humerus Plating System
- Midshaft Humerus Plating System

The Skeletal Dynamics Humeral Plating Set contains bone plates for the repair of distal and midshaft humerus fractures. Included in the set are bone screws, k-wires, and specialized instrumentation.

### Indications for Use

The Skeletal Dynamics Distal Humerus Plating System is indicated for the fixation of fractures, osteotomies, and nonunion of the distal humerus.

The Skeletal Dynamics Midshaft Humerus Plating System is indicated for fixation of fractures, peri-prosthetic fractures, nonunion, and malunions in the humeral shaft of adult patients including those with osteopenic bone.

### Distal Humerus Plates

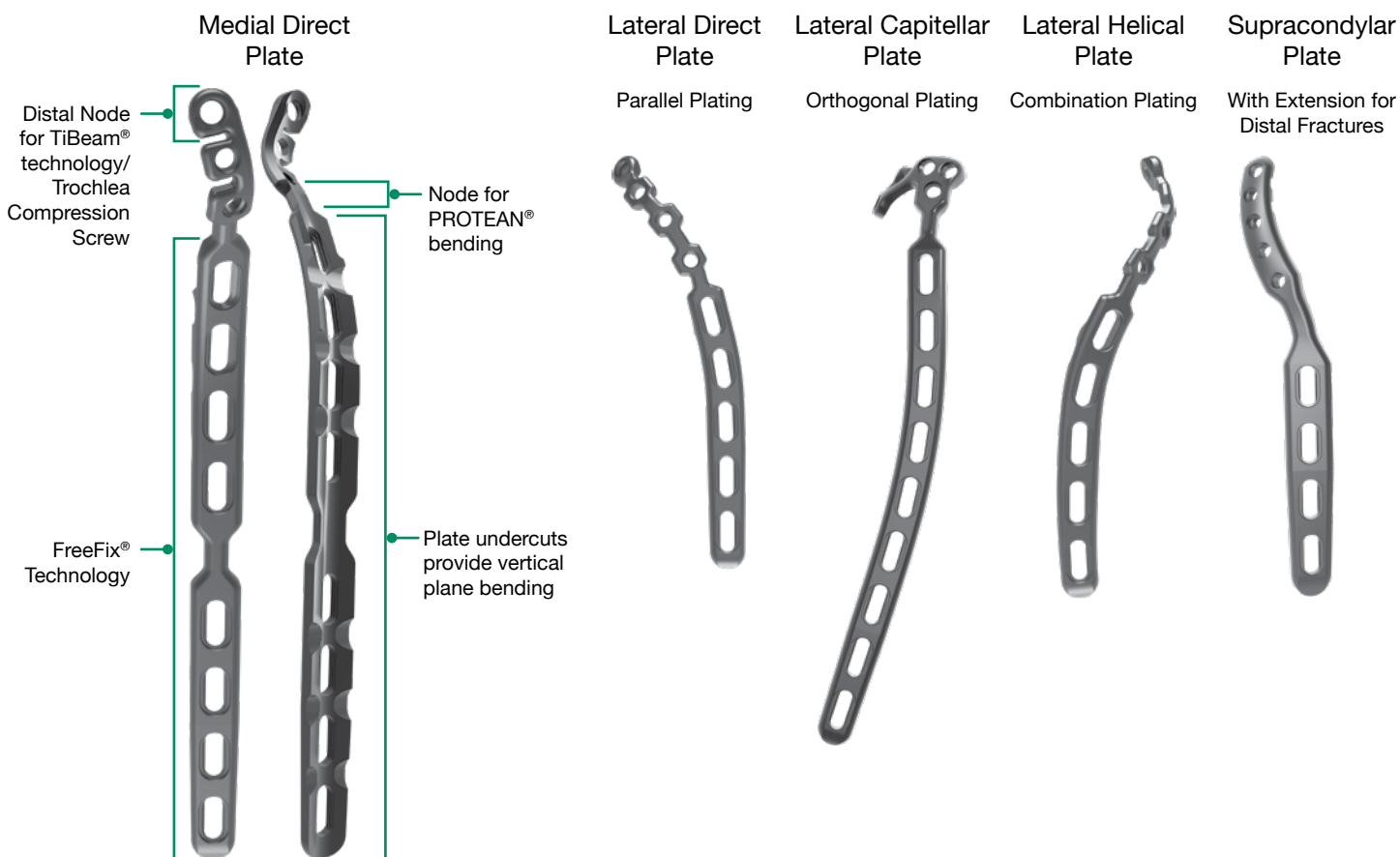

### Midshaft Humerus Plates

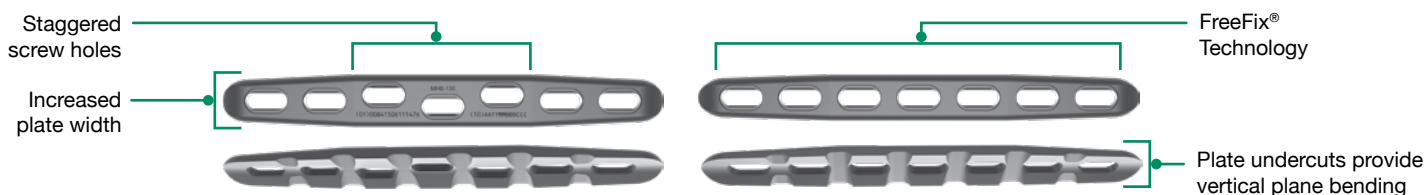

## 1 SUPERFICIAL EXPOSURE

---



Make a posterior incision.

## 2 DEEP EXPOSURE

---



Use caution to identify and release the ulnar nerve.

Expose the ulna for an olecranon osteotomy.

## PREPARING OLECRANON OSTEOTOMY

3

Place a 3 hole proximal ulna plate on the surface of the proximal ulna.

Make a narrow incision, parallel to the tendon fibers and through the triceps insertion, to apply the home-run tab onto the surface of the olecranon.

Note the presence of osteophytes on the olecranon. Osteophytes may prevent plate from sitting flush with bone.

Drill through the center of the gliding hole using the 2.7mm x 50mm drill bit.

Using the appropriate scale of the depth gauge, measure then insert a 3.5mm compression screw (FreeFix® compression screw) and tighten with the T-10 driver.



DRLL-SSC-27050: Drill, 2.7mm x 50mm



DPGA-HPS: Depth Gauge, HPS



DRVR-UQC-T10: Driver, Universal Quick Connect, T10



FFC-35XXX-TS: Screw, FreeFix® Compression, 3.5mm x XXmm, Ti

## PREPARING OLECRANON OSTEOTOMY

4

Drill through the home-run tab using the 2.7mm x 80mm drill bit. Using the appropriate scale on the metaphyseal side of the depth gauge, measure and insert a 3.5mm compression screw (multi-thread compression) and tighten with a T-10 driver to reduce the plate to the ulna.



DRLL-SSC-27080: Drill, 2.7mm x 80mm



MTNL-35XXX-TS: Screw, Multi-Thread Compression, 3.5mm x XXmm, Ti

# 5 PREPARING OLECRANON OSTEOTOMY

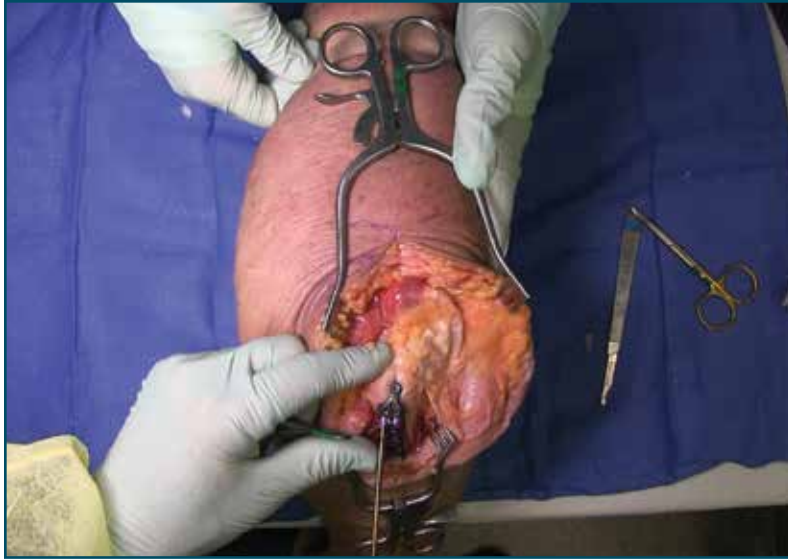

With the plate firmly on the ulna, drill the two olecranon screw holes using the 2.7mm x 50mm drill bit.

The plate will be used as a template to direct the osteotomy placement and restore original ulnar anatomy during closing.

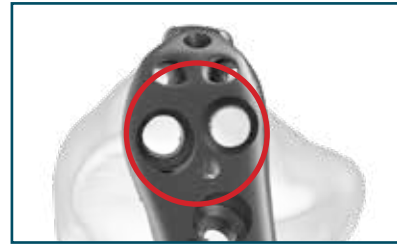

# 6 PREPARING OLECRANON OSTEOTOMY

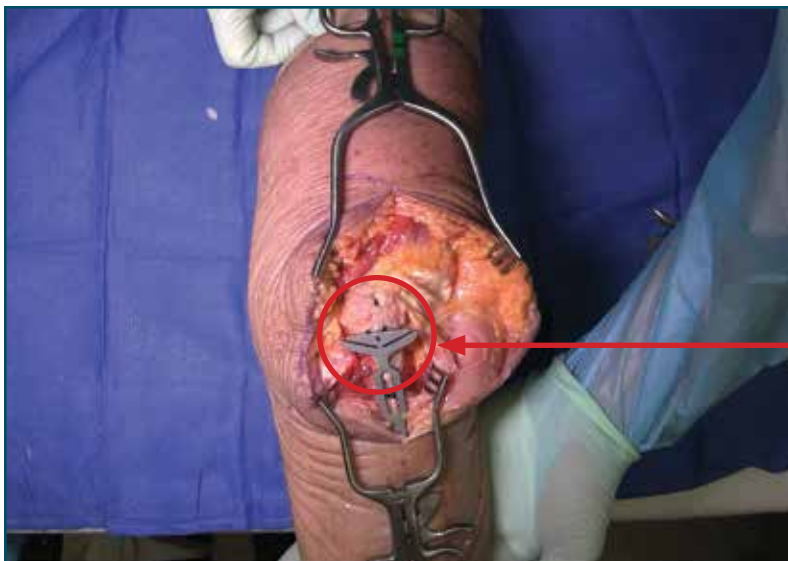

Remove the proximal ulna plate. Apply the osteotomy cutting guide with the grooved side facing the bone and insert a 3.5mm compression screw in the gliding slot.

Position the proximal edge of the cutting guide level with the two pre-drilled olecranon screw holes.



DHP-OOG: Olecranon Osteotomy Guide

## PREPARING OLECRANON OSTEOTOMY

7

Further secure the cutting guide by inserting a 2.0mm k-wire in either the proximal or distal guide wire hole. Tighten the 3.5mm compression screw to prevent vibrational loosening while cutting.

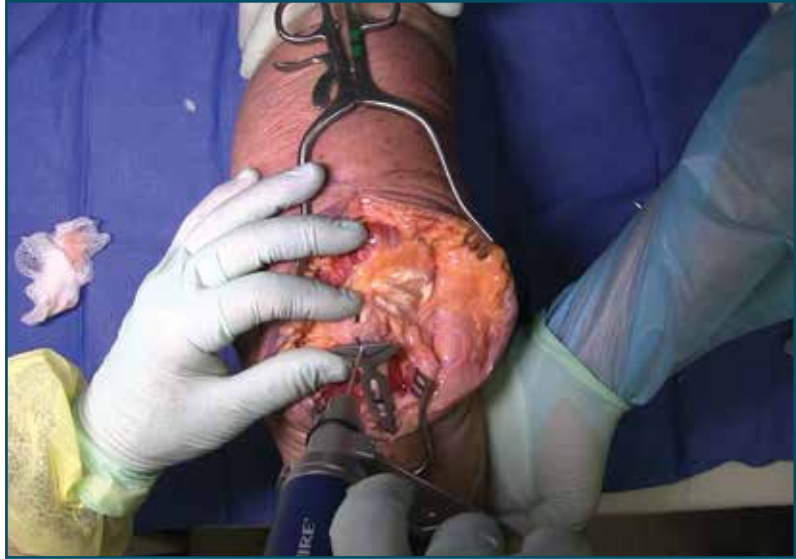

KWIR-SD-20152: K-Wire, Single Diamond, 2.0 mm x 152 mm

## OLECRANON OSTEOTOMY

8

Perform the olecranon osteotomy using a blade with minimum dimensions of 12mm wide and 15mm long.

**Note:**

Gauze can be used to protect the articular surface from being damaged during the osteotomy.

Remove the olecranon guide and complete the osteotomy using a saw or osteotome.

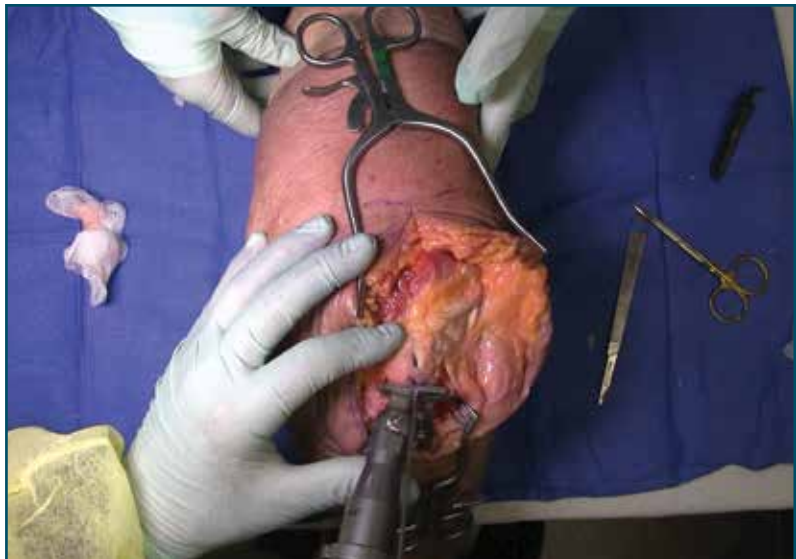

# 9

## FRACTURE EXPOSURE

---



Reflect the olecranon and triceps proximally, exposing the fracture.

**Note:**

Use caution to identify and protect the radial nerve as needed.

# 10

## ARTICULAR FRAGMENT REDUCTION

---

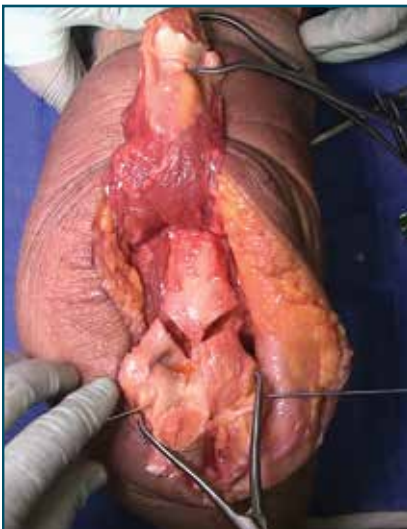

Debride the fracture sites and reduce articular fragments.

Bone holding forceps, k-wires or large reduction forceps may assist in achieving reduction.

**Note:**

Use caution to identify and protect the ulnar nerve.



FRCP-BHL-SL: Forceps, Bone Holding Large, Speed Lock



FRCP-BRF-SL: Large Reduction Forceps, Speed Lock



FRCP-BRF-LR: Reduction Forceps, Long Ratcheting

---

KWIR-SD-15127: K-Wire, Single Diamond, 1.5mm x 127mm



Reduce the articular portion to the humeral shaft using 1.5mm k-wires. The k-wire in each column should be placed as posterior and close to the midline as possible to prevent interference during trochlea compression screw insertion.

**Note:**

Bone holding forceps or large reduction forceps may assist in achieving reduction.

Release soft tissue from the tip of the medial and lateral epicondyles, and any osteophytes present, to expose for plate application.

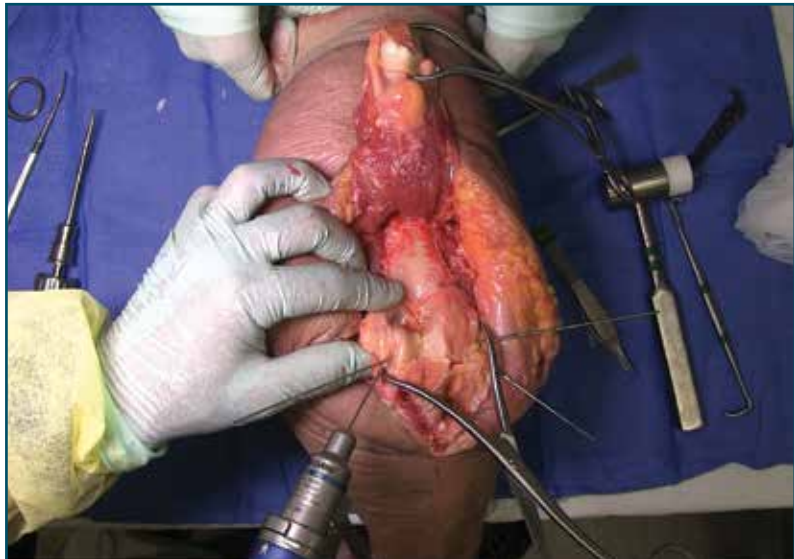

Select the first plate (medial or lateral). If necessary, contour to optimize fit using bending instruments.

**Warning:**

Caution should be taken when contouring plates. Bending the plates may weaken or break the plates.

If using bending pliers, a Locking Cap can be applied temporarily to prevent deformation of the distal hole.

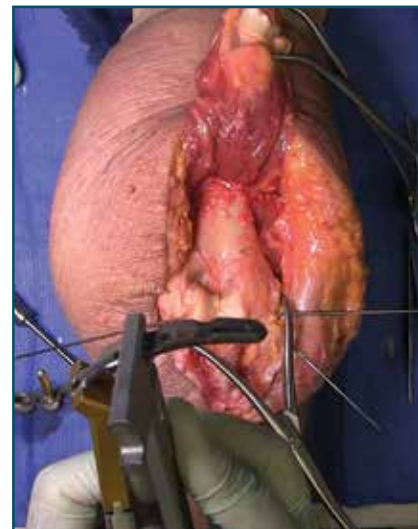

RT-BND-PLL: PROTEAN®  
Plate Bending Pliers, Large



BND-ROD-DHP: Bending Rod, DHP



UNV-BND-35: Universal Bending  
Irons, 3.5mm



UNV-BND-45: Universal Bending  
Irons, 4.5mm

# 13 SHAFT FIXATION



Position the plate such that the epicondylar screw hole (2nd node on the plate) is located on the apex of the epicondyle.

First, fix the plate to the proximal fragment. Using the HPS drill guide, drill through the chosen FreeFix® slot using the 2.7mm x 50mm drill bit. Using the FreeFix® scale of the depth gauge, measure then insert a 3.5mm compression screw (FreeFix® Compression) for fixation to the humeral shaft.

**Note:**  
If necessary, trim the epicondyle osteophyte with a rongeur to improve plate fit.

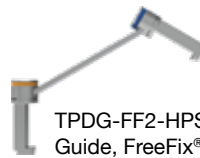

TPDG-FF2-HPS: Drill Guide, FreeFix®, HPS



TPDG-FF2-35: Thread-in Drill Guide, FreeFix®, 3.5mm

# 14 DISTAL FRAGMENT FIXATION

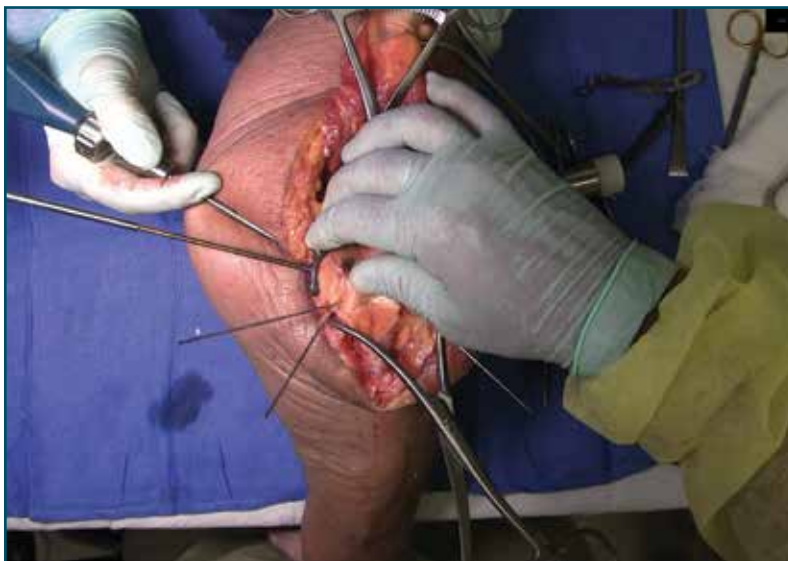

Provisionally secure the articular portion to the shaft by inserting, through the epicondylar node, a 2.7mm provisional smooth peg or a 2.0mm k-wire as follows:

If a 3.5mm metaphyseal screws will be later used for final fixation, use a 2.7mm drill bit to drill through the epicondylar holes and insert the smooth pegs with the T-10 driver.

If using 2.7mm metaphyseal screws for final fixation, insert the 2.0mm AIMing guide into the pre-loaded drill guide and drill through the epicondyle with a 2.0mm k-wire.



KWIR-SDS-20152: K-Wire, Single Diamond with Stop, 2.0 mm x 152 mm



SPLS-27100-TS: Smooth Peg, Locking, 2.7mm x 10mm, Ti



PDG-AIM-20SF: AIMing Guides, 2.0mm Snap Fit

Repeat steps 11 through 14 for the second plate.

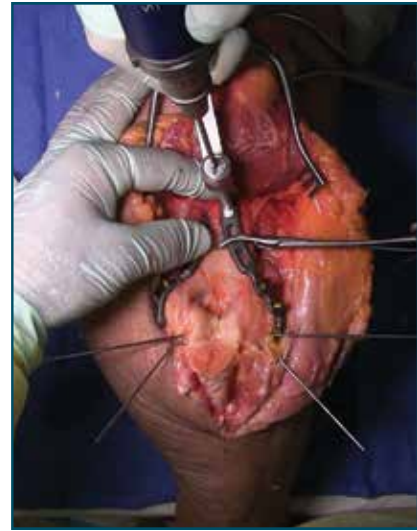
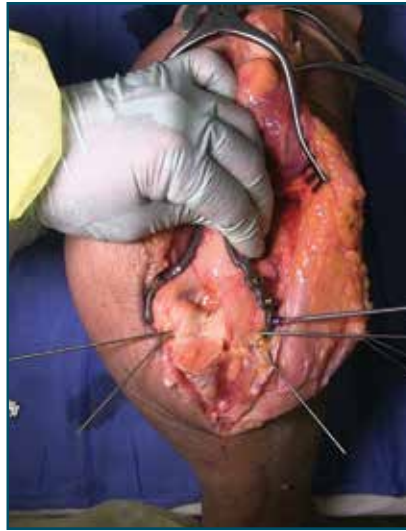

## TiBeam® CANAL PREPARATION

# 16

If using TiBeam®, utilize the trajectory guide to insert the 1.5mm x 229mm k-wire between the most distal holes of the medial and lateral plates starting through the bushing sleeve. Length is measured using marks on the bushing sleeve. A standard depth gauge can also be used, measuring from plate to plate. If impingement occurs, replace temporary fixation k-wires as needed. Ensure the trajectory guide is fully seated in the distal holes.

The measurement guide on the thumb screw should start at 0mm and should only be used for micro-adjustments.

It is recommended to use a male TiBeam® component rounded down to the nearest 5mm. Overlay selected components on the bone to confirm size. For example, if the length measured is 68mm, select a 65mm male TiBeam® component.

Distal Trochlea Compression Screws may be used in the distal holes instead of the TiBeam® by drilling with the 2.7mm x 80mm drill bit and measuring with the metaphyseal scale of the depth gauge.

**Note:**

To prevent the k-wire skiving off the epicondyles, predrill the cortex with a 2.7mm drill bit.

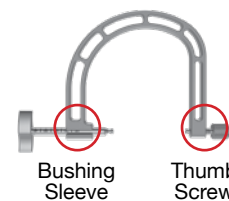

DHP-TG: Distal Humerus Plate, Trajectory Guide

# 17 TiBeam® CANAL PREPARATION



Drill over the k-wire through both plates using the 3.7mm x 80mm cannulated drill bit. Drilling from the opposite direction of k-wire insertion facilitates this step.

Prepare for the female TiBeam® component by drilling over the k-wire in the same direction using the 4.0mm x 20mm stop drill.



DRLL-CDC-40020: Drill, Cannulated, 4.0mm x 20mm



DRLL-CDC-37080: Cannulated Drill, 3.7mm x 80mm

# 18 TiBeam® ASSEMBLY



Remove the trochlea k-wire by inserting the Trochlea Compression Screw Insertion Tool to push out the k-wire . Place the female trochlea compression screw onto the tip of the insertion tool to keep the internal threads clean.

Using the T-10 driver insert the female TiBeam® component while pulling the insertion tool until the female component is fully seated in the plate.

Remove the insertion tool and insert the male TiBeam® component utilizing the T-10 driver.



TCS-M-XX: TiBeam®, Trochlea Compression Screw, Male, XXmm



TCS-F: TiBeam®, Trochlea Compression Screw, Female



TCS-INS: TiBeam®, Trochlea Compression Screw, Insertion Tool

With both drivers in place, engage the male and female components and compress the trochlea fragments. Confirm TiBeam® engagement and compression with fluoroscopy.

**Note:**

Take care not to over compress the fragments. Before final compression, make sure the plates are in their desired position.



**TROCHLEA SUPPORT SCREWS - MEDIAL PLATE** **20**

Remove the provisional fixation from the epicondylar holes and perform final fixation with the chosen screws.

If using 3.5mm screws, drill through the thread-in drill guide with the 2.7mm x 80mm drill bit. Measure with the depth gauge and insert the appropriate 3.5mm metaphyseal screw.

If using 2.7mm screws, drill through the thread-in drill guide using the 2.0mm x 80mm drill bit. Measure with the depth gauge and insert the appropriate 2.7mm metaphyseal screw.



**Note:**

If desired, polyaxial locking screws are available for insertion into the head of both plates. Refer to the optional steps on page 18. Drill under fluoroscopy to take care not to penetrate articular surface.



TPDG-27-MXL: Thread-in Drill Guide, 2.7mm, Multi-Thread, XL



TPDG-20-MXL: Thread-in Drill Guide, 2.0mm XL



MTNL-35XXX-TS: Screw, Multi-Thread Compression, 3.5mm x XXmm, Ti

## 21 TROCHLEAR SUPPORT SCREWS - MEDIAL PLATE

---

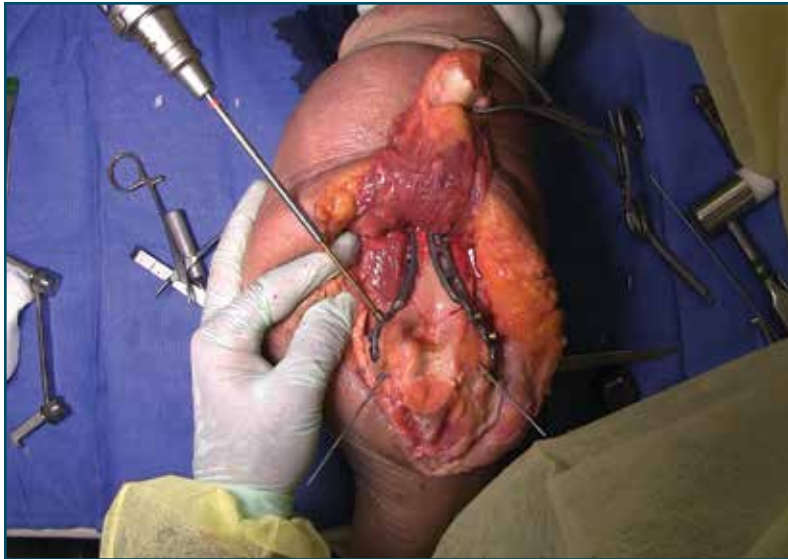

Starting with the third hole of the medial plate, work proximally to finish inserting all metaphyseal screws. Using the 2.7mm x 80mm drill bit for 3.5mm screws or with the 2.0mm x 80mm drill bit for 2.7mm screws, measure screw length with appropriate depth gauge and insert the selected screw.

**Note:**

Drill under fluoroscopy to take care not to penetrate articular surface.



MTNL-27XXX-TS: Screw, Multi-Thread, Compression, 2.7mm x XXmm, Ti



MTLS-27XXX-TS: Screw, Multi-Thread, Locking, 2.7mm x XXmm, Ti

## 22 TROCHLEA SUPPORT SCREWS - LATERAL PLATE

---



Repeat steps 20-21 on the lateral side.

# DIAPHYSEAL FIXATION 23

Fill the remaining holes in the humeral shaft FreeFix® slots with 3.5mm locking or compression screws using the HPS or 3.5mm thread-in drill guide, and 2.7mm x 50mm drill bit.

**Note:**

1.5mm of dynamic compression can be achieved at any slot using the eccentric hole on the drill guide. Make sure the reference arrow is pointing towards the fracture.

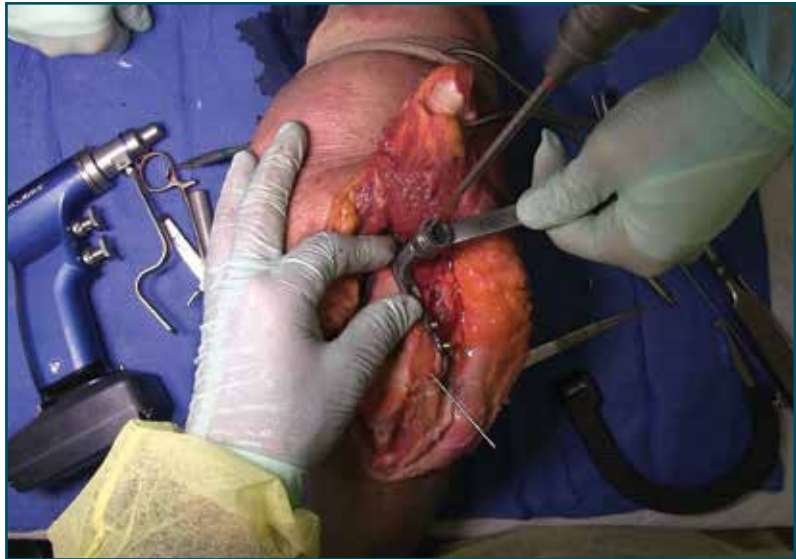

TPDG-FF2-HPS: Drill Guide, FreeFix®, HPS



TPDG-FF2-35: Thread-in Drill Guide, FreeFix®, 3.5mm



FFL-35XXX-TS: Screw, FreeFix® Locking, 3.5mm x XXmm, Ti

# LOCKING CAP 24

When reduction is complete, insert a locking cap into each distal node to create a fixed TiBeam® construct.

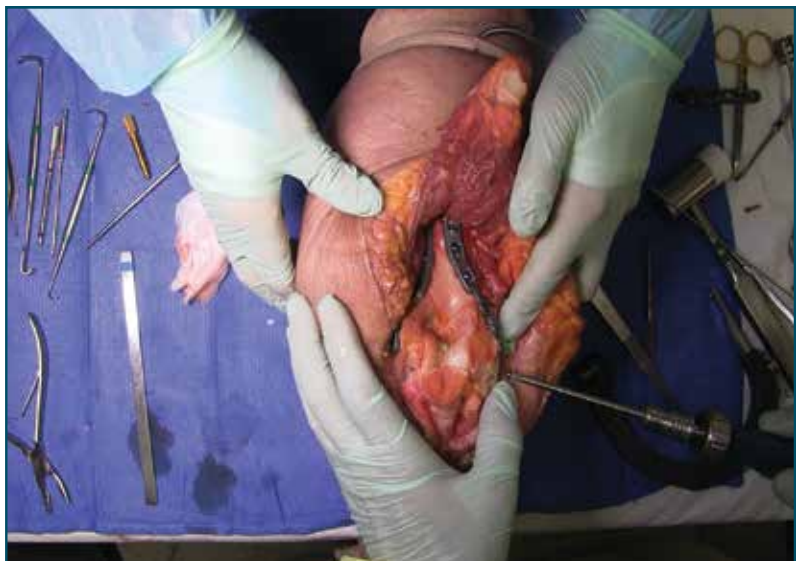

TCS-LC: TiBeam®, Trochlea Compression Screw, Locking Cap

# 25 CLOSURE

---



Once fixation is complete, reduce the olecranon and apply the proximal ulna plate. Use the home-run screw to ensure compression across the osteotomy site. Fill all the screw holes for optimal fixation.

**Note:**

Be sure to over drill the olecranon fragment with the 3.5mm drill bit. Close the incision and dress the wound in the usual fashion.





## 1

### CANNULATED 3.0 POLYAXIAL LOCKING SCREW SETUP



If a polyaxial locking screw is needed in any of the threaded holes, use the T-10 driver to remove the preloaded drill guides if present and insert the 1.1mm PLS AIMing guide.

Insert a 1.1mm k-wire through the polyaxial locking screw AIMing guide in the desired trajectory until the far cortex is reached.

**Note:**

Fluoroscopy is helpful to confirm the trajectory of the k-wire.



PDG-AIM-011: PLS AIMing Guide, 1.1mm x 10°

KWIR-HPS-PLS: K-Wire, 1.1 mm x 152 mm

## 2

### FLUOROSCOPIC CONFIRMATION



After confirming the k-wire is inserted to the far cortex, use the cannulated 3.0 polyaxial locking screw T-10 driver to remove the polyaxial locking screw AIMing Guide leaving the k-wire in place.



DRVR-PLS-30C: Driver, 3.0 PLS, T-10

## CANNULATED 3.0 POLYAXIAL PREPARATION

3

Slide the cannulated depth gauge over the k-wire to measure the appropriate length of the screw. Using the 2.4mm cannulated PLS drill bit, drill over the k-wire to the proper depth.

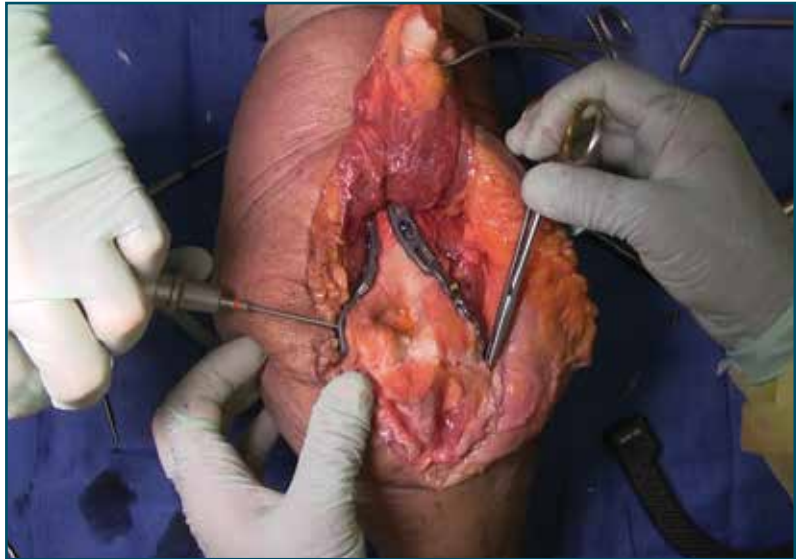

DPGA-PLS-3070: Cannulated Depth Gauge, Polyaxial Locking Screw, 3.0mm x 70mm



DRLL-PLS-24: Drill, Cannulated, PLS, 2.4mm x 40mm

## CANNULATED 3.0 POLYAXIAL FIXATION

4

Using the cannulated 3.0mm polyaxial locking screw T-10 driver, thread the screw down to the k-wire until the head of the screw contacts the plate.

Remove the k-wire and fully lock the screw to the plate using the non-cannulated T-10 driver.

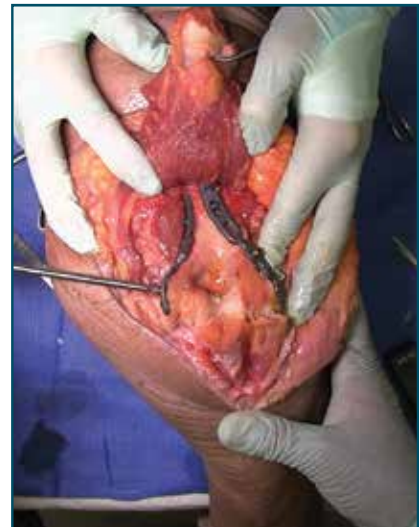

PALS-30XXX-CC: Screw, Polyaxial Locking, 3.0mm x XXmm Cannulated, CoCr



DRVR-UQC-T10: Driver, Universal Quick Connect, T10

# 5

## FLUOROSCOPIC CONFIRMATION

---



Using fluoroscopic imaging, confirm that proper reduction has been maintained and that all screws are of proper length and fully engaged to the plate.

Confirm that all pre-loaded drill guides have been removed.



## 1

### EXPOSURE

---

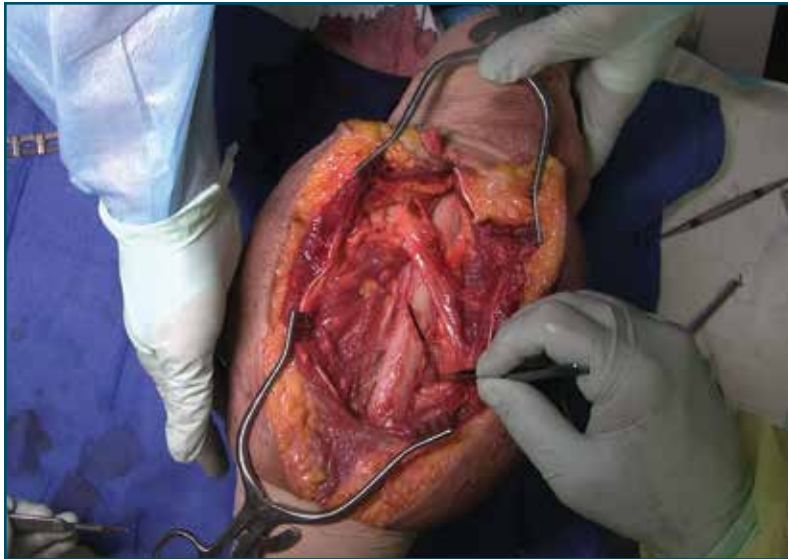

Expose the humerus using the optimal approach for the fracture location.

Use caution to identify and protect the nerves and vasculature.

## 2

### REDUCE FRACTURE

---

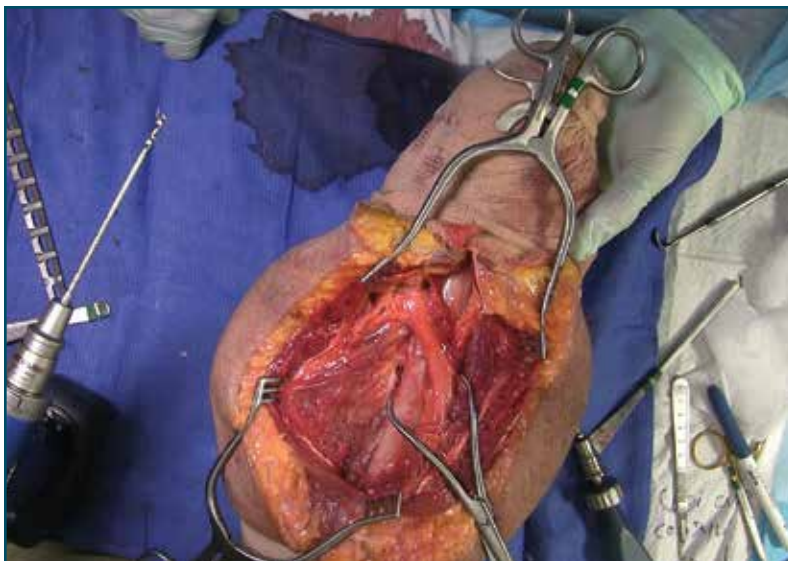

Debride and reduce the fracture. Address fracture pattern using lag screws as needed. Bone clamps are useful for provisional fixation.

## INSERT LAG SCREW

# 3

If the fracture does not require use of a lag screw, proceed to plate selection in Step 4.

Place the lag screw as perpendicularly as possible to the fracture line. Use the 3.5mm x 50mm drill bit with the tissue protector drill guide to drill the near cortex. Insert the 2.7mm end of the guide into the hole previously drilled and use the 2.7mm x 50mm drill bit to drill through the far cortex. Countersinking the near cortex may be required to limit screw head prominence. Measure and insert the desired 3.5mm cortex screw.

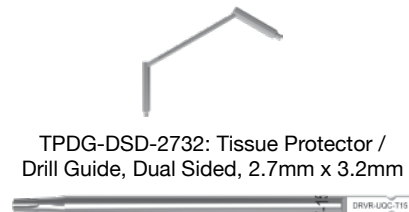
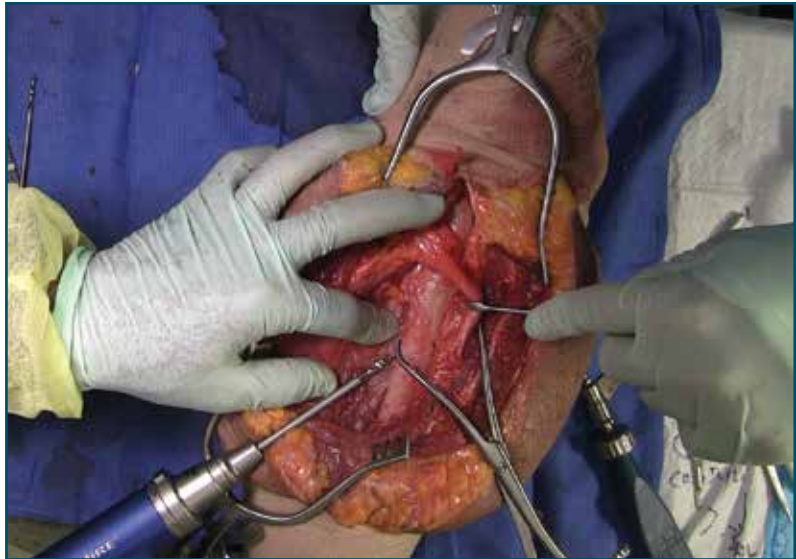

TPDG-DSD-2732: Tissue Protector / Drill Guide, Dual Sided, 2.7mm x 3.2mm



DRVR-UQC-T15: Driver, Universal Quick Connect, T15



DRLL-SSC-27050: Drill, 2.7mm x 50mm



FFC-45XXX-TS: Screw, FreeFix® Compression, 4.5mm x XXmm, Ti



DRLL-SSC-35070: Drill, 3.5mm x 50mm



DRLL-CSK-65: Countersink, 6.5mm

## PLATE SELECTION

# 4

Select the appropriate plate type and length. Six cortices are recommended proximal and distal to the extent of the fracture.

Forceps can be used to aid in plate placement or fracture reduction.

If needed, use bending irons to bend the plate for precise anatomical fit.

### Warning:

Caution should be taken when contouring plates. Bending the plates may weaken or break the plates.

Move and protect the radial nerve while placing the humeral plate.

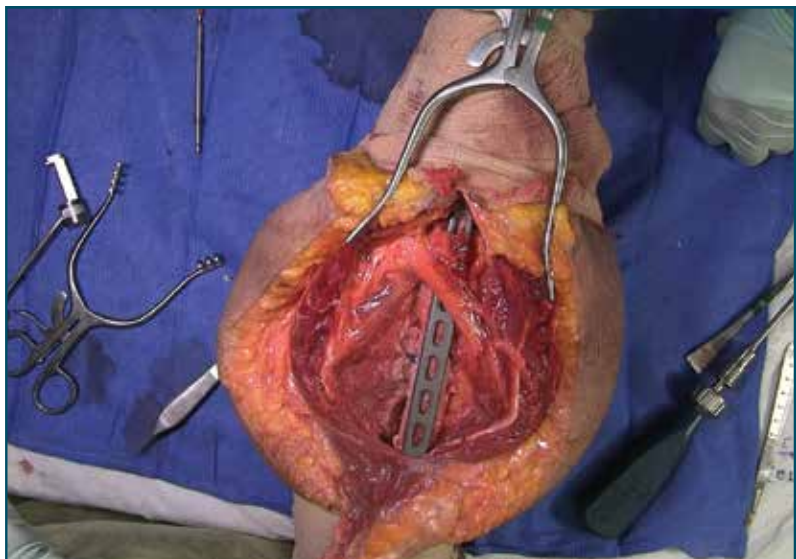

# 5

## PLATE FIXATION

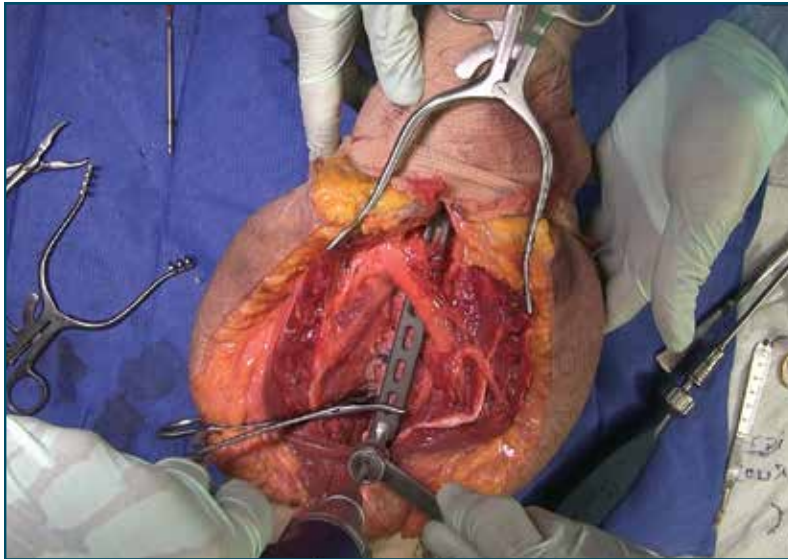

Utilizing the center hole of the drill guide, drill a pilot hole in a chosen FreeFix® slot on one side of the fracture.

Using the FreeFix® scale of the depth gauge, measure then insert a 4.5mm compression screw (non-locking cortical screw) and tighten with the T-15 driver.

Repeat this step on the opposite side of the fracture to compress the plate to the bone.



DPGA-HPS: Depth Gauge, HPS



TPDG-FF2-HPS: Drill Guide, FreeFix®, HPS

# 6

## DYNAMIC COMPRESSION

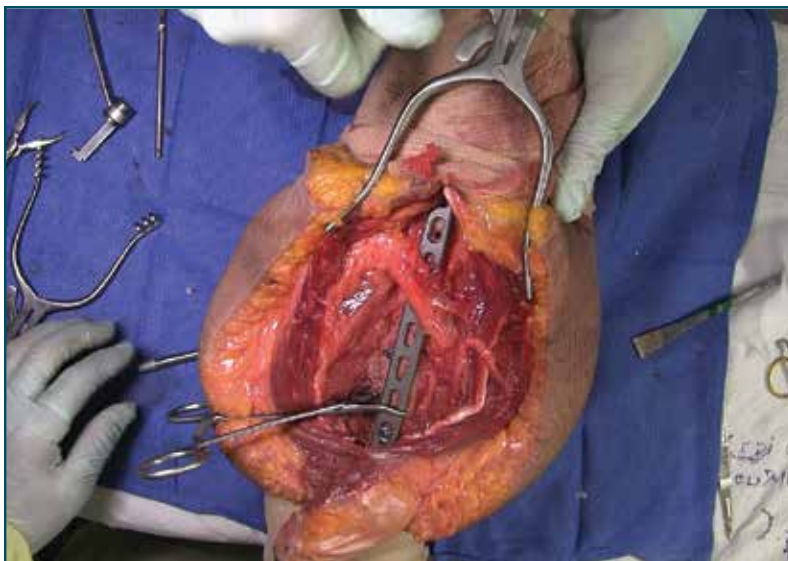

Place the drill guide in the chosen slot, ensuring the off-center hole of the guide is furthest from the fracture.

Drill through the off-center hole, then measure using the depth gauge to determine the appropriate screw length.

**Note:**

FreeFix® plates have a patented horizontal thread pattern which allows dynamic compression with either compression or locking screws.

Before engaging the head of the screw with the threads of the screw, loosen any previously placed screws on the corresponding side of the fracture. Then tighten the screw for dynamic compression.

Once the screw is fully seated, retighten any previously loosened screws.



## FINAL PLATE FIXATION

7

Fill the necessary screw holes on each side of the fracture to provide the recommended minimum six cortices of stability. The thread-in drill guide can be used to insert screws at any location within the slots.

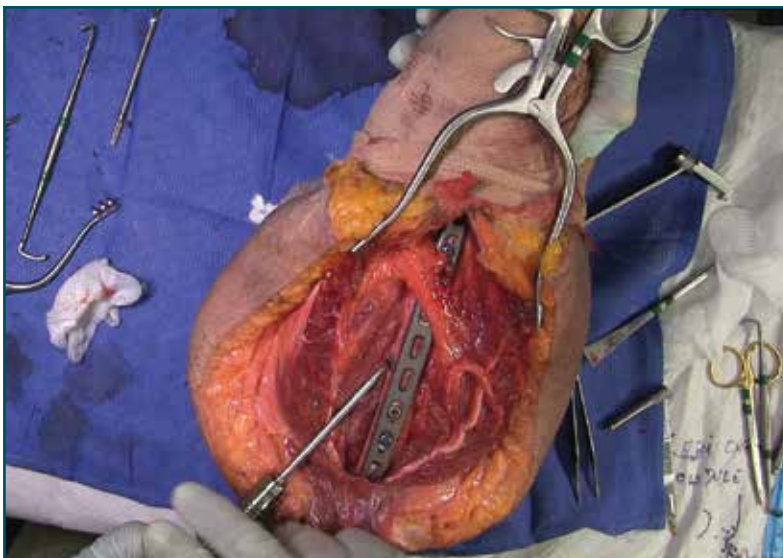

FFL-45XXX-TS: Screw, FreeFix® Locking, 4.5mm x XXmm, Ti



TPDG-FF-45: Thread-in Drill Guide, FreeFix®, 4.5mm

## FINAL CONFIRMATION

8

Confirm proper reduction, alignment and screw length with fluoroscopy.

Close the incision in the usual fashion.

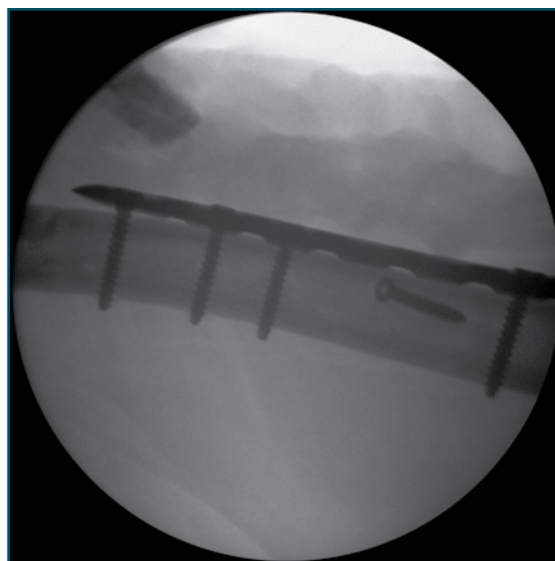

# INSTRUMENT TRAY (Standard Configuration)

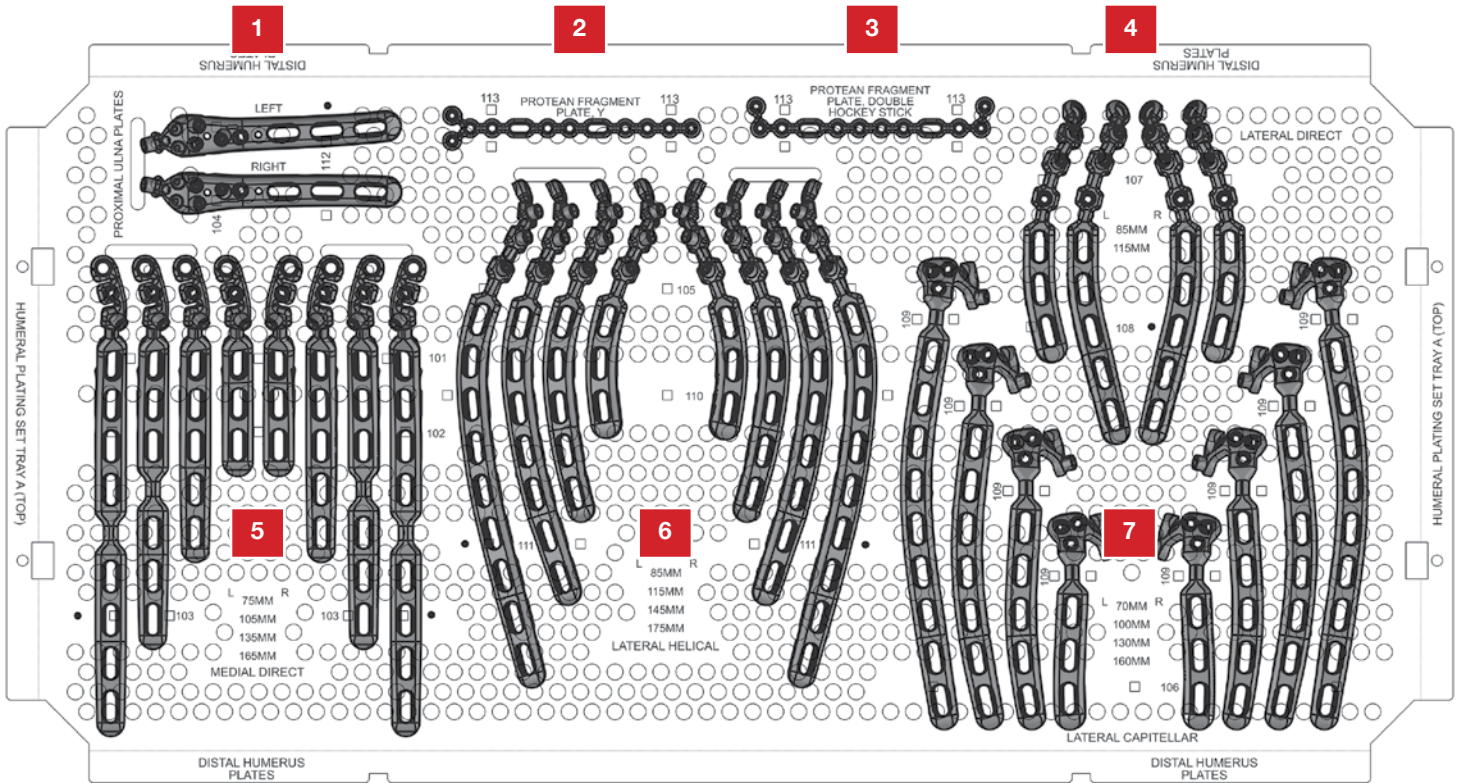

## Loc# Catalog# Description

1	APL-PUP-3HR APL-PUP-3HL	Proximal Ulna Plate, 73mm, Right Proximal Ulna Plate, 73mm, Left
2	PRT-SP-LR	Assembled, PROTEAN Fragment Plate, Double Hockey Stick
3	PRT-SP-YS	Assembled, PROTEAN Fragment Plate, Y
4	DHPF-LDR-3HL DHPF-LDL-3HL DHPF-LDR-5HL DHPF-LDL-5HL	FreeFix®, Distal Humerus Plate, Lateral Direct, 85mm, Right FreeFix®, Distal Humerus Plate, Lateral Direct, 85mm, Left FreeFix®, Distal Humerus Plate, Lateral Direct, 115mm, Right FreeFix®, Distal Humerus Plate, Lateral Direct, 115mm, Left
5	DHPF-MDR-3HL DHPF-MDL-3HL DHPF-MDR-5HL DHPF-MDL-5HL DHPF-MDR-6HL DHPF-MDL-6HL DHPF-MDR-8HL DHPF-MDL-8HL	FreeFix®, Distal Humerus Plate, Medial Direct, 75mm, Right FreeFix®, Distal Humerus Plate, Medial Direct, 75mm, Left FreeFix®, Distal Humerus Plate, Medial Direct, 105mm, Right FreeFix®, Distal Humerus Plate, Medial Direct, 105mm, Left FreeFix®, Distal Humerus Plate, Medial Direct, 135mm, Right FreeFix®, Distal Humerus Plate, Medial Direct, 135mm, Left FreeFix®, Distal Humerus Plate, Medial Direct, 165mm, Right FreeFix®, Distal Humerus Plate, Medial Direct, 165mm, Left
6	DHPF-LHR-3HL DHPF-LHL-3HL DHPF-LHR-5HL DHPF-LHL-5HL DHPF-LHR-7HL DHPF-LHL-7HL DHPF-LHR-9HL DHPF-LHL-9HL	FreeFix®, Distal Humerus Plate, Lateral Helical, 85mm, Right FreeFix®, Distal Humerus Plate, Lateral Helical, 85mm, Left FreeFix®, Distal Humerus Plate, Lateral Helical, 115mm, Right FreeFix®, Distal Humerus Plate, Lateral Helical, 115mm, Left FreeFix®, Distal Humerus Plate, Lateral Helical, 145mm, Right FreeFix®, Distal Humerus Plate, Lateral Helical, 145mm, Left FreeFix®, Distal Humerus Plate, Lateral Helical, 175mm, Right FreeFix®, Distal Humerus Plate, Lateral Helical, 175mm, Left
7	DHPF-LCR-3HL DHPF-LCL-3HL DHPF-LCR-5HL DHPF-LCL-5HL DHPF-LCR-7HL DHPF-LCL-7HL DHPF-LCR-9HL DHPF-LCL-9HL	FreeFix®, Distal Humerus Plate, Lateral Capitellar, 70mm, Right FreeFix®, Distal Humerus Plate, Lateral Capitellar, 70mm, Left FreeFix®, Distal Humerus Plate, Lateral Capitellar, 100mm, Right FreeFix®, Distal Humerus Plate, Lateral Capitellar, 100mm, Left FreeFix®, Distal Humerus Plate, Lateral Capitellar, 130mm, Right FreeFix®, Distal Humerus Plate, Lateral Capitellar, 130mm, Left FreeFix®, Distal Humerus Plate, Lateral Capitellar, 160mm, Right FreeFix®, Distal Humerus Plate, Lateral Capitellar, 160mm, Left

# INSTRUMENT TRAY (Standard Configuration)

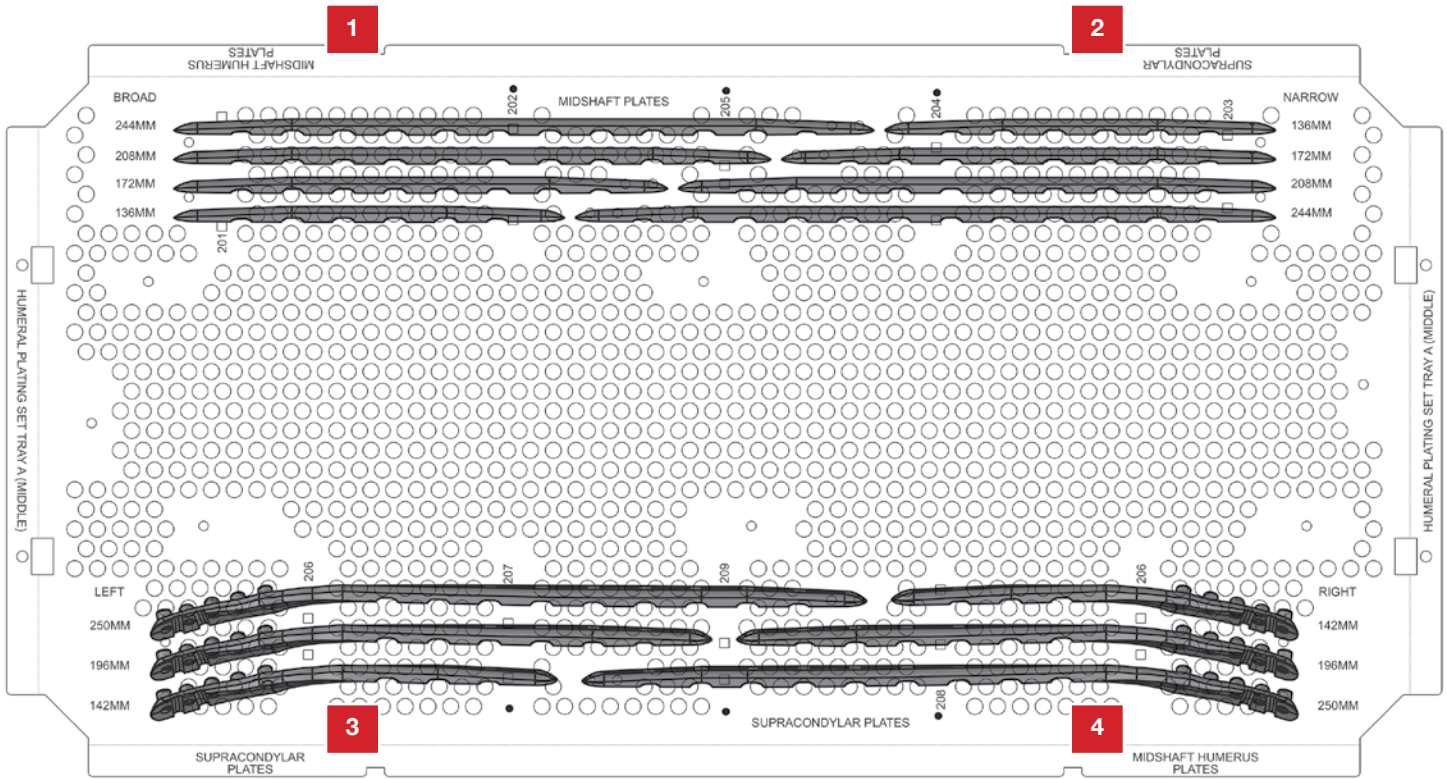

Loc#	Catalog#	Description
------	----------	-------------

1	MHB-136	Midshaft Humerus Plate, Broad 136mm
	MHB-172	Midshaft Humerus Plate, Broad 172mm
	MHB-208	Midshaft Humerus Plate, Broad 208mm
	MHB-244	Midshaft Humerus Plate, Broad 244mm
2	MHN-136	Midshaft Humerus Plate, Narrow 136mm
	MHN-172	Midshaft Humerus Plate, Narrow 172mm
	MHN-208	Midshaft Humerus Plate, Narrow 208mm
	MHN-244	Midshaft Humerus Plate, Narrow 244mm
3	SCL-142	Distal Humerus Plate, Supracondylar, 142mm, Left
	SCL-196	Distal Humerus Plate, Supracondylar, 196mm, Left
	SCL-250	Distal Humerus Plate, Supracondylar, 250mm, Left
4	SCR-142	Distal Humerus Plate, Supracondylar, 142mm, Right
	SCR-196	Distal Humerus Plate, Supracondylar, 196mm, Right
	SCR-250	Distal Humerus Plate, Supracondylar, 250mm, Right

# INSTRUMENT TRAY (Standard Configuration)

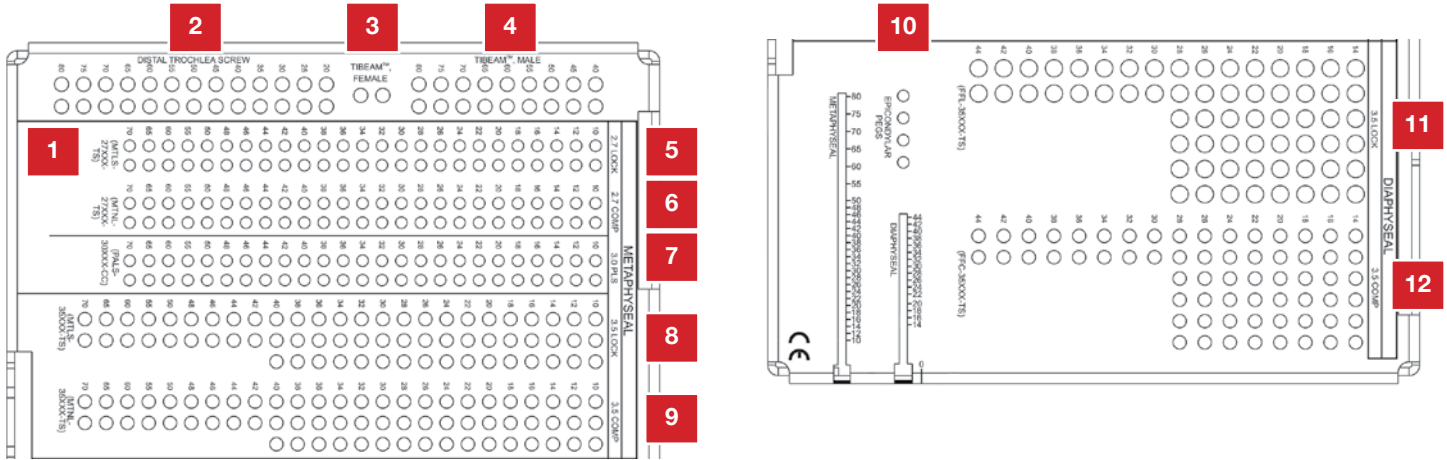

Loc#	Catalog#	Description	Loc#	Catalog#	Description
------	----------	-------------	------	----------	-------------

1	TCS-LC	TiBeam®, Trochlea Compression Screw, Locking Cap			
2	DTCS-35020 DTCS-35025 DTCS-35030 DTCS-35035 DTCS-35040 DTCS-35045 DTCS-35050 DTCS-35055 DTCS-35060 DTCS-35065 DTCS-35070 DTCS-35075 DTCS-35080	Distal Trochlea Compression Screw, 3.5mm x 20mm, Ti Distal Trochlea Compression Screw, 3.5mm x 25mm, Ti Distal Trochlea Compression Screw, 3.5mm x 30mm, Ti Distal Trochlea Compression Screw, 3.5mm x 35mm, Ti Distal Trochlea Compression Screw, 3.5mm x 40mm, Ti Distal Trochlea Compression Screw, 3.5mm x 45mm, Ti Distal Trochlea Compression Screw, 3.5mm x 50mm, Ti Distal Trochlea Compression Screw, 3.5mm x 55mm, Ti Distal Trochlea Compression Screw, 3.5mm x 60mm, Ti Distal Trochlea Compression Screw, 3.5mm x 65mm, Ti Distal Trochlea Compression Screw, 3.5mm x 70mm, Ti Distal Trochlea Compression Screw, 3.5mm x 75mm, Ti Distal Trochlea Compression Screw, 3.5mm x 80mm, Ti			
3	TCS-F	TiBeam®, Trochlea Compression Screw, Female			
4	TCS-M-40 TCS-M-45 TCS-M-50 TCS-M-55 TCS-M-60 TCS-M-65 TCS-M-70 TCS-M-75 TCS-M-80	TiBeam®, Trochlea Compression Screw, Male, 40mm TiBeam®, Trochlea Compression Screw, Male, 45mm TiBeam®, Trochlea Compression Screw, Male, 50mm TiBeam®, Trochlea Compression Screw, Male, 55mm TiBeam®, Trochlea Compression Screw, Male, 60mm TiBeam®, Trochlea Compression Screw, Male, 65mm TiBeam®, Trochlea Compression Screw, Male, 70mm TiBeam®, Trochlea Compression Screw, Male, 75mm TiBeam®, Trochlea Compression Screw, Male, 80mm			
5	MTLS-27100-TS MTLS-27120-TS MTLS-27140-TS MTLS-27160-TS MTLS-27180-TS MTLS-27200-TS MTLS-27220-TS MTLS-27240-TS MTLS-27260-TS MTLS-27280-TS MTLS-27300-TS MTLS-27320-TS MTLS-27340-TS MTLS-27360-TS MTLS-27380-TS MTLS-27400-TS MTLS-27420-TS MTLS-27440-TS MTLS-27460-TS MTLS-27480-TS MTLS-27500-TS MTLS-27550-TS MTLS-27600-TS MTLS-27650-TS MTLS-27700-TS	Screw, Multi-Thread, Locking, 2.7mm x 10mm, Ti Screw, Multi-Thread, Locking, 2.7mm x 12mm, Ti Screw, Multi-Thread, Locking, 2.7mm x 14mm, Ti Screw, Multi-Thread, Locking, 2.7mm x 16mm, Ti Screw, Multi-Thread, Locking, 2.7mm x 18mm, Ti Screw, Multi-Thread, Locking, 2.7mm x 20mm, Ti Screw, Multi-Thread, Locking, 2.7mm x 22mm, Ti Screw, Multi-Thread, Locking, 2.7mm x 24mm, Ti Screw, Multi-Thread, Locking, 2.7mm x 26mm, Ti Screw, Multi-Thread, Locking, 2.7mm x 28mm, Ti Screw, Multi-Thread, Locking, 2.7mm x 30mm, Ti Screw, Multi-Thread, Locking, 2.7mm x 32mm, Ti Screw, Multi-Thread, Locking, 2.7mm x 34mm, Ti Screw, Multi-Thread, Locking, 2.7mm x 36mm, Ti Screw, Multi-Thread, Locking, 2.7mm x 38mm, Ti Screw, Multi-Thread, Locking, 2.7mm x 40mm, Ti Screw, Multi-Thread, Locking, 2.7mm x 42mm, Ti Screw, Multi-Thread, Locking, 2.7mm x 44mm, Ti Screw, Multi-Thread, Locking, 2.7mm x 46mm, Ti Screw, Multi-Thread, Locking, 2.7mm x 48mm, Ti Screw, Multi-Thread, Locking, 2.7mm x 50mm, Ti Screw, Multi-Thread, Locking, 2.7mm x 55mm, Ti Screw, Multi-Thread, Locking, 2.7mm x 60mm, Ti Screw, Multi-Thread, Locking, 2.7mm x 65mm, Ti Screw, Multi-Thread, Locking, 2.7mm x 70mm, Ti			
6	MTNL-27100-TS MTNL-27120-TS MTNL-27140-TS MTNL-27160-TS MTNL-27180-TS MTNL-27200-TS MTNL-27220-TS MTNL-27240-TS MTNL-27260-TS MTNL-27280-TS	Screw, Multi-Thread, Compression, 2.7mm x 10mm, Ti Screw, Multi-Thread, Compression, 2.7mm x 12mm, Ti Screw, Multi-Thread, Compression, 2.7mm x 14mm, Ti Screw, Multi-Thread, Compression, 2.7mm x 16mm, Ti Screw, Multi-Thread, Compression, 2.7mm x 18mm, Ti Screw, Multi-Thread, Compression, 2.7mm x 20mm, Ti Screw, Multi-Thread, Compression, 2.7mm x 22mm, Ti Screw, Multi-Thread, Compression, 2.7mm x 24mm, Ti Screw, Multi-Thread, Compression, 2.7mm x 26mm, Ti Screw, Multi-Thread, Compression, 2.7mm x 28mm, Ti			
7	PALS-30100-CC PALS-30120-CC PALS-30140-CC PALS-30160-CC PALS-30180-CC PALS-30200-CC PALS-30220-CC PALS-30240-CC PALS-30260-CC PALS-30280-CC PALS-30300-CC PALS-30320-CC PALS-30340-CC PALS-30360-CC PALS-30380-CC PALS-30400-CC PALS-30420-CC PALS-30440-CC PALS-30460-CC PALS-30480-CC PALS-30500-CC PALS-30550-CC PALS-30600-CC PALS-30650-CC PALS-30700-CC	Screw, Polyaxial Locking, 3.0mm x 10mm Cannulated, CoCr Screw, Polyaxial Locking, 3.0mm x 12mm Cannulated, CoCr Screw, Polyaxial Locking, 3.0mm x 14mm Cannulated, CoCr Screw, Polyaxial Locking, 3.0mm x 16mm Cannulated, CoCr Screw, Polyaxial Locking, 3.0mm x 18mm Cannulated, CoCr Screw, Polyaxial Locking, 3.0mm x 20mm Cannulated, CoCr Screw, Polyaxial Locking, 3.0mm x 22mm Cannulated, CoCr Screw, Polyaxial Locking, 3.0mm x 24mm Cannulated, CoCr Screw, Polyaxial Locking, 3.0mm x 26mm Cannulated, CoCr Screw, Polyaxial Locking, 3.0mm x 28mm Cannulated, CoCr Screw, Polyaxial Locking, 3.0mm x 30mm Cannulated, CoCr Screw, Polyaxial Locking, 3.0mm x 32mm Cannulated, CoCr Screw, Polyaxial Locking, 3.0mm x 34mm Cannulated, CoCr Screw, Polyaxial Locking, 3.0mm x 36mm Cannulated, CoCr Screw, Polyaxial Locking, 3.0mm x 38mm Cannulated, CoCr Screw, Polyaxial Locking, 3.0mm x 40mm Cannulated, CoCr Screw, Polyaxial Locking, 3.0mm x 42mm Cannulated, CoCr Screw, Polyaxial Locking, 3.0mm x 44mm Cannulated, CoCr Screw, Polyaxial Locking, 3.0mm x 46mm Cannulated, CoCr Screw, Polyaxial Locking, 3.0mm x 48mm Cannulated, CoCr Screw, Polyaxial Locking, 3.0mm x 50mm Cannulated, CoCr Screw, Polyaxial Locking, 3.0mm x 55mm Cannulated, CoCr Screw, Polyaxial Locking, 3.0mm x 60mm Cannulated, CoCr Screw, Polyaxial Locking, 3.0mm x 65mm Cannulated, CoCr Screw, Polyaxial Locking, 3.0mm x 70mm Cannulated, CoCr	7		
8	MTLS-35100-TS MTLS-35120-TS MTLS-35140-TS MTLS-35160-TS MTLS-35180-TS MTLS-35200-TS MTLS-35220-TS MTLS-35240-TS MTLS-35260-TS MTLS-35280-TS MTLS-35300-TS MTLS-35320-TS MTLS-35340-TS MTLS-35360-TS MTLS-35380-TS MTLS-35400-TS MTLS-35420-TS MTLS-35440-TS MTLS-35460-TS MTLS-35480-TS MTLS-35500-TS MTLS-35550-TS	Screw, Multi-Thread Locking, 3.5mm x 10mm, Ti Screw, Multi-Thread Locking, 3.5mm x 12mm, Ti Screw, Multi-Thread Locking, 3.5mm x 14mm, Ti Screw, Multi-Thread Locking, 3.5mm x 16mm, Ti Screw, Multi-Thread Locking, 3.5mm x 18mm, Ti Screw, Multi-Thread Locking, 3.5mm x 20mm, Ti Screw, Multi-Thread Locking, 3.5mm x 22mm, Ti Screw, Multi-Thread Locking, 3.5mm x 24mm, Ti Screw, Multi-Thread Locking, 3.5mm x 26mm, Ti Screw, Multi-Thread Locking, 3.5mm x 28mm, Ti Screw, Multi-Thread Locking, 3.5mm x 30mm, Ti Screw, Multi-Thread Locking, 3.5mm x 32mm, Ti Screw, Multi-Thread Locking, 3.5mm x 34mm, Ti Screw, Multi-Thread Locking, 3.5mm x 36mm, Ti Screw, Multi-Thread Locking, 3.5mm x 38mm, Ti Screw, Multi-Thread Locking, 3.5mm x 40mm, Ti Screw, Multi-Thread Locking, 3.5mm x 42mm, Ti Screw, Multi-Thread Locking, 3.5mm x 44mm, Ti Screw, Multi-Thread Locking, 3.5mm x 46mm, Ti Screw, Multi-Thread Locking, 3.5mm x 48mm, Ti Screw, Multi-Thread Locking, 3.5mm x 50mm, Ti Screw, Multi-Thread Locking, 3.5mm x 55mm, Ti			

# INSTRUMENT TRAY (Standard Configuration)

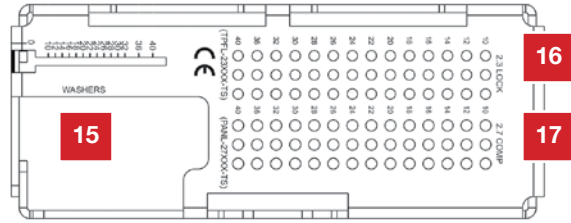
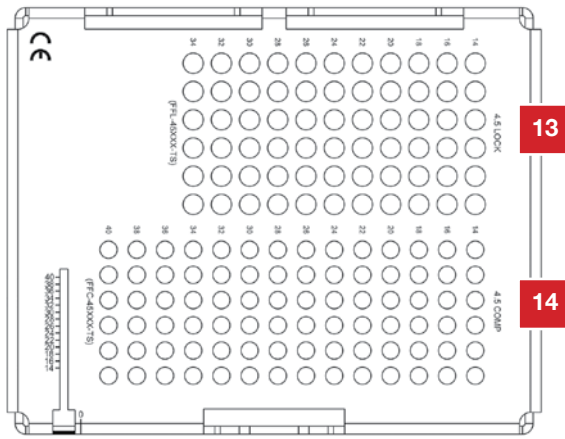

Loc#	Catalog#	Description	Loc#	Catalog#	Description
------	----------	-------------	------	----------	-------------

	MTLS-35600-TS	Screw, Multi-Thread Locking, 3.5mm x 60mm, Ti		FFC-35440-TS	Screw, FreeFix® Compression, 3.5mm x 44mm, Ti
	MTLS-35650-TS	Screw, Multi-Thread Locking, 3.5mm x 65mm, Ti			
	MTLS-35700-TS	Screw, Multi-Thread Locking, 3.5mm x 70mm, Ti			
9	MTNL-35100-TS	Screw, Multi-Thread Compression, 3.5mm x 10mm, Ti	13	FFL-45140-TS	Screw, FreeFix® Locking, 4.5mm x 14mm, Ti
	MTNL-35120-TS	Screw, Multi-Thread Compression, 3.5mm x 12mm, Ti		FFL-45160-TS	Screw, FreeFix® Locking, 4.5mm x 16mm, Ti
	MTNL-35140-TS	Screw, Multi-Thread Compression, 3.5mm x 14mm, Ti		FFL-45180-TS	Screw, FreeFix® Locking, 4.5mm x 18mm, Ti
	MTNL-35160-TS	Screw, Multi-Thread Compression, 3.5mm x 16mm, Ti		FFL-45200-TS	Screw, FreeFix® Locking, 4.5mm x 20mm, Ti
	MTNL-35180-TS	Screw, Multi-Thread Compression, 3.5mm x 18mm, Ti		FFL-45220-TS	Screw, FreeFix® Locking, 4.5mm x 22mm, Ti
	MTNL-35200-TS	Screw, Multi-Thread Compression, 3.5mm x 20mm, Ti		FFL-45240-TS	Screw, FreeFix® Locking, 4.5mm x 24mm, Ti
	MTNL-35220-TS	Screw, Multi-Thread Compression, 3.5mm x 22mm, Ti		FFL-45260-TS	Screw, FreeFix® Locking, 4.5mm x 26mm, Ti
	MTNL-35240-TS	Screw, Multi-Thread Compression, 3.5mm x 24mm, Ti		FFL-45280-TS	Screw, FreeFix® Locking, 4.5mm x 28mm, Ti
	MTNL-35260-TS	Screw, Multi-Thread Compression, 3.5mm x 26mm, Ti		FFL-45300-TS	Screw, FreeFix® Locking, 4.5mm x 30mm, Ti
	MTNL-35280-TS	Screw, Multi-Thread Compression, 3.5mm x 28mm, Ti		FFL-45320-TS	Screw, FreeFix® Locking, 4.5mm x 32mm, Ti
	MTNL-35300-TS	Screw, Multi-Thread Compression, 3.5mm x 30mm, Ti		FFL-45340-TS	Screw, FreeFix® Locking, 4.5mm x 34mm, Ti
	MTNL-35320-TS	Screw, Multi-Thread Compression, 3.5mm x 32mm, Ti	14	FFC-45140-TS	Screw, FreeFix® Compression, 4.5mm x 14mm, Ti
	MTNL-35340-TS	Screw, Multi-Thread Compression, 3.5mm x 34mm, Ti		FFC-45160-TS	Screw, FreeFix® Compression, 4.5mm x 16mm, Ti
	MTNL-35360-TS	Screw, Multi-Thread Compression, 3.5mm x 36mm, Ti		FFC-45180-TS	Screw, FreeFix® Compression, 4.5mm x 18mm, Ti
	MTNL-35380-TS	Screw, Multi-Thread Compression, 3.5mm x 38mm, Ti		FFC-45200-TS	Screw, FreeFix® Compression, 4.5mm x 20mm, Ti
	MTNL-35400-TS	Screw, Multi-Thread Compression, 3.5mm x 40mm, Ti		FFC-45220-TS	Screw, FreeFix® Compression, 4.5mm x 22mm, Ti
	MTNL-35420-TS	Screw, Multi-Thread Compression, 3.5mm x 42mm, Ti		FFC-45240-TS	Screw, FreeFix® Compression, 4.5mm x 24mm, Ti
	MTNL-35440-TS	Screw, Multi-Thread Compression, 3.5mm x 44mm, Ti		FFC-45260-TS	Screw, FreeFix® Compression, 4.5mm x 26mm, Ti
	MTNL-35460-TS	Screw, Multi-Thread Compression, 3.5mm x 46mm, Ti		FFC-45280-TS	Screw, FreeFix® Compression, 4.5mm x 28mm, Ti
	MTNL-35480-TS	Screw, Multi-Thread Compression, 3.5mm x 48mm, Ti		FFC-45300-TS	Screw, FreeFix® Compression, 4.5mm x 30mm, Ti
	MTNL-35500-TS	Screw, Multi-Thread Compression, 3.5mm x 50mm, Ti		FFC-45320-TS	Screw, FreeFix® Compression, 4.5mm x 32mm, Ti
	MTNL-35550-TS	Screw, Multi-Thread Compression, 3.5mm x 55mm, Ti		FFC-45340-TS	Screw, FreeFix® Compression, 4.5mm x 34mm, Ti
	MTNL-35600-TS	Screw, Multi-Thread Compression, 3.5mm x 60mm, Ti		FFC-45360-TS	Screw, FreeFix® Compression, 4.5mm x 36mm, Ti
	MTNL-35650-TS	Screw, Multi-Thread Compression, 3.5mm x 65mm, Ti		FFC-45380-TS	Screw, FreeFix® Compression, 4.5mm x 38mm, Ti
	MTNL-35700-TS	Screw, Multi-Thread Compression, 3.5mm x 70mm, Ti		FFC-45400-TS	Screw, FreeFix® Compression, 4.5mm x 40mm, Ti
10	SPLS-27100-TS	Smooth Peg, Locking, 2.7mm x 10mm, Ti	15	WBTN-HCLP	Washer, Button (Bronze)
11	FFL-35160-TS	Screw, FreeFix® Locking, 3.5mm x 16mm, Ti	16	TPFL-23100-TS	Threaded Peg, Fluted, Locking, 2.3mm x 10mm, Ti
	FFL-35180-TS	Screw, FreeFix® Locking, 3.5mm x 18mm, Ti		TPFL-23120-TS	Threaded Peg, Fluted, Locking, 2.3mm x 12mm, Ti
	FFL-35200-TS	Screw, FreeFix® Locking, 3.5mm x 20mm, Ti		TPFL-23140-TS	Threaded Peg, Fluted, Locking, 2.3mm x 14mm, Ti
	FFL-35220-TS	Screw, FreeFix® Locking, 3.5mm x 22mm, Ti		TPFL-23160-TS	Threaded Peg, Fluted, Locking, 2.3mm x 16mm, Ti
	FFL-35240-TS	Screw, FreeFix® Locking, 3.5mm x 24mm, Ti		TPFL-23180-TS	Threaded Peg, Fluted, Locking, 2.3mm x 18mm, Ti
	FFL-35260-TS	Screw, FreeFix® Locking, 3.5mm x 26mm, Ti		TPFL-23200-TS	Threaded Peg, Fluted, Locking, 2.3mm x 20mm, Ti
	FFL-35280-TS	Screw, FreeFix® Locking, 3.5mm x 28mm, Ti		TPFL-23220-TS	Threaded Peg, Fluted, Locking, 2.3mm x 22mm, Ti
	FFL-35300-TS	Screw, FreeFix® Locking, 3.5mm x 30mm, Ti		TPFL-23240-TS	Threaded Peg, Fluted, Locking, 2.3mm x 24mm, Ti
	FFL-35320-TS	Screw, FreeFix® Locking, 3.5mm x 32mm, Ti		TPFL-23260-TS	Threaded Peg, Fluted, Locking, 2.3mm x 26mm, Ti
	FFL-35340-TS	Screw, FreeFix® Locking, 3.5mm x 34mm, Ti		TPFL-23280-TS	Threaded Peg, Fluted, Locking, 2.3mm x 28mm, Ti
	FFL-35360-TS	Screw, FreeFix® Locking, 3.5mm x 36mm, Ti		TPFL-23300-TS	Threaded Peg, Fluted, Locking, 2.3mm x 30mm, Ti
	FFL-35380-TS	Screw, FreeFix® Locking, 3.5mm x 38mm, Ti		TPFL-23320-TS	Threaded Peg, Fluted, Locking, 2.3mm x 32mm, Ti
	FFL-35400-TS	Screw, FreeFix® Locking, 3.5mm x 40mm, Ti		TPFL-23360-TS	Threaded Peg, Fluted, Locking, 2.3mm x 36mm, Ti
	FFL-35420-TS	Screw, FreeFix® Locking, 3.5mm x 42mm, Ti		TPFL-23400-TS	Threaded Peg, Fluted, Locking, 2.3mm x 40mm, Ti
	FFL-35440-TS	Screw, FreeFix® Locking, 3.5mm x 44mm, Ti	17	PANL-27100-TS	Threaded Peg, Cortical Non-Locking, 2.7mm x 10mm, Ti
12	FFC-35140-TS	Screw, FreeFix® Compression, 3.5mm x 14mm, Ti		PANL-27120-TS	Threaded Peg, Cortical Non-Locking, 2.7mm x 12mm, Ti
	FFC-35160-TS	Screw, FreeFix® Compression, 3.5mm x 16mm, Ti		PANL-27140-TS	Threaded Peg, Cortical Non-Locking, 2.7mm x 14mm, Ti
	FFC-35180-TS	Screw, FreeFix® Compression, 3.5mm x 18mm, Ti		PANL-27160-TS	Threaded Peg, Cortical Non-Locking, 2.7mm x 16mm, Ti
	FFC-35200-TS	Screw, FreeFix® Compression, 3.5mm x 20mm, Ti		PANL-27180-TS	Threaded Peg, Cortical Non-Locking, 2.7mm x 18mm, Ti
	FFC-35220-TS	Screw, FreeFix® Compression, 3.5mm x 22mm, Ti		PANL-27200-TS	Threaded Peg, Cortical Non-Locking, 2.7mm x 20mm, Ti
	FFC-35240-TS	Screw, FreeFix® Compression, 3.5mm x 24mm, Ti		PANL-27220-TS	Threaded Peg, Cortical Non-Locking, 2.7mm x 22mm, Ti
	FFC-35260-TS	Screw, FreeFix® Compression, 3.5mm x 26mm, Ti		PANL-27240-TS	Threaded Peg, Cortical Non-Locking, 2.7mm x 24mm, Ti
	FFC-35280-TS	Screw, FreeFix® Compression, 3.5mm x 28mm, Ti		PANL-27260-TS	Threaded Peg, Cortical Non-Locking, 2.7mm x 26mm, Ti
	FFC-35300-TS	Screw, FreeFix® Compression, 3.5mm x 30mm, Ti		PANL-27280-TS	Threaded Peg, Cortical Non-Locking, 2.7mm x 28mm, Ti
	FFC-35320-TS	Screw, FreeFix® Compression, 3.5mm x 32mm, Ti		PANL-27300-TS	Threaded Peg, Cortical Non-Locking, 2.7mm x 30mm, Ti
	FFC-35340-TS	Screw, FreeFix® Compression, 3.5mm x 34mm, Ti		PANL-27320-TS	Threaded Peg, Cortical Non-Locking, 2.7mm x 32mm, Ti
	FFC-35360-TS	Screw, FreeFix® Compression, 3.5mm x 36mm, Ti		PANL-27360-TS	Threaded Peg, Cortical Non-Locking, 2.7mm x 36mm, Ti
	FFC-35380-TS	Screw, FreeFix® Compression, 3.5mm x 38mm, Ti		PANL-27400-TS	Threaded Peg, Cortical Non-Locking, 2.7mm x 40mm, Ti
	FFC-35400-TS	Screw, FreeFix® Compression, 3.5mm x 40mm, Ti			
	FFC-35420-TS	Screw, FreeFix® Compression, 3.5mm x 42mm, Ti			

## INSTRUMENT TRAY (Standard Configuration)

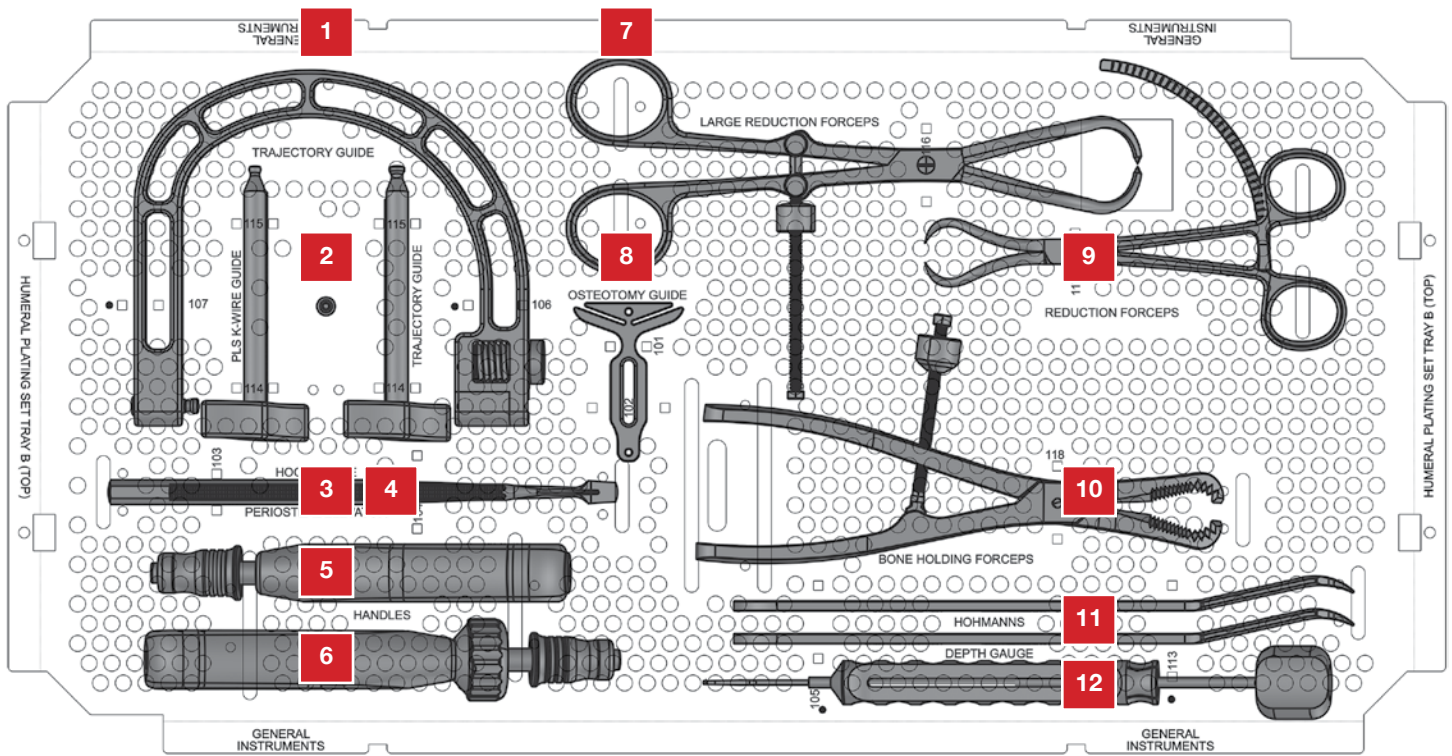

Loc#	Catalog#	Description
------	----------	-------------

1	DHP-TG	Distal Humerus Plate, Trajectory Guide
2	HPS-PLS-TG	HPS PLS K-Wire Guide
3	INST-SHP-STD	Instrument, Sharp Hook Probe, Standard
4	INST-KPE-STD	Instrument, Key Periosteal Elevator, Standard
5	HNDL-UQC-RTC	Handle, Universal QC, Ratcheting
6	HNDL-UQC-FXD	Handle, Universal QC, Fixed
7	FRCP-BRF-SL	Large Reduction Forceps, Speed Lock
8	DHP-OOG	Olecranon Osteotomy Guide
9	FRCP-BRF-LR	Reduction Forceps, Long Ratcheting
10	FRCP-BHL-SL	Forceps, Bone Holding Large, Speed Lock
11	INST-HR-LRG	Instrument, Hohmann Retractor, Large
12	DPGA-HPS	Depth Gauge, HPS

# INSTRUMENT TRAY (Standard Configuration)

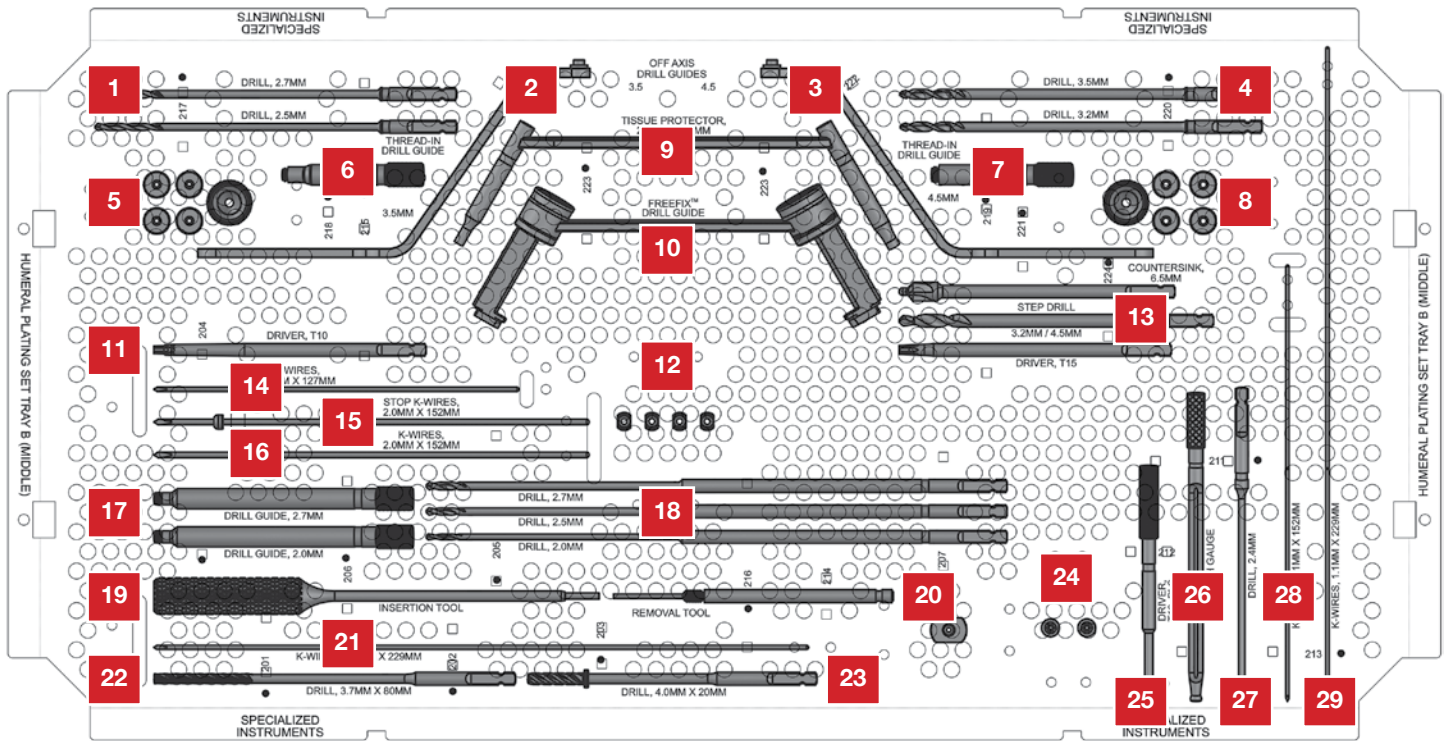

Loc#	Catalog#	Description	Loc#	Catalog#	Description
------	----------	-------------	------	----------	-------------

1	DRLL-SSC-27050 DRLL-SSC-25050	Drill, 2.7mm x 50mm Drill, 2.5mm x 50mm	18	DRLL-SSC-27080 DRLL-SSC-25080 DRLL-SSC-20080	Drill, 2.7mm x 80mm Drill, 2.5mm x 80mm Drill, 2.0mm x 80mm
2	OADG-FF-35	Off Axis Drill Guide, FreeFix® 3.5mm	19	TCS-INS	TiBeam®, Trochlea Compression Screw, Insertion Tool
3	OADG-FF-45	Off Axis Drill Guide, FreeFix® 4.5mm	20	TCS-REM	TiBeam®, Trochlea Compression Screw, Removal Tool
4	DRLL-SSC-32050 DRLL-SSC-35050	Drill, 3.2mm x 50mm Drill, 3.5mm x 50mm	21	KWIR-SD-15229	K-Wire, Single Diamond, 1.5 mm x 229 mm
5	OADG-FF-T35 TPDG-FF2-KW16	Thread-in Off Axis Drill Guide, FreeFix® 3.5mm Thread-In Drill Guide, FreeFix®, 1.6mm K-Wire	22	DRLL-CDC-37080	Cannulated Drill, 3.7mm x 80mm
6	TPDG-FF2-35	Thread-in Drill Guide, FreeFix®, 3.5mm	23	DRLL-CDC-40020	Drill, Cannulated, 4.0mm x 20mm
7	TPDG-FF-45	Thread-in Drill Guide, FreeFix®, 4.5mm	24	PDG-AIM-011	PLS AIMing Guide, 1.1mm x 10°
8	TPDG-FF-KW20 OADG-FF-T45	Thread-In Drill Guide, FreeFix®, 2.0mm K-Wire Thread-in Off Axis Drill Guide, FreeFix® 4.5mm	25	DRVR-PLS-30C	Driver, 3.0 PLS, T-10
9	TPDG-DSD-2735	Tissue Protector / Drill Guide, Dual Sided, 2.7mm x 3.5mm	26	DPGA-PLS-3070	Cannulated Depth Gauge, Polyaxial Locking Screw, 3.0mm x 70mm
10	TPDG-FF2-HPS	Drill Guide, FreeFix®, HPS	27	DRLL-PLS-24	Drill, Cannulated, PLS, 2.4mm x 40mm
11	DRVR-UQC-T10	Driver, Universal Quick Connect, T10	28	KWIR-HPS-PLS	K-Wire, Standard Tip, HPS PLS, 1.1 mm x 152 mm
12	PDG-AIM-20SF	AIMing Guides, 2.0mm Snap Fit	29	KWIR-PLS-11229	K-Wire, Standard Tip, HPS PLS, 1.1 mm x 229 mm
13	DRLL-CSK-65 DRLL-STP-3245 DRVR-UQC-T15	Countersink, 6.5mm Drill, 3.2mm/4.5mm Driver, Universal Quick Connect, T15			
14	KWIR-SD-15127	K-Wire, Single Diamond, 1.5mm x 127mm			
15	KWIR-SDS-20152	K-Wire, Single Diamond with Stop, 2.0 mm x 152 mm			
16	KWIR-SD-20152	K-Wire, Single Diamond, 2.0 mm x 152 mm			
17	TPDG-27-MXL TPDG-20-MXL	Thread-in Drill Guide, 2.7mm, Multi-Thread, XL Thread-in Drill Guide, 2.0mm XL			

# INSTRUMENT TRAY (Standard Configuration)

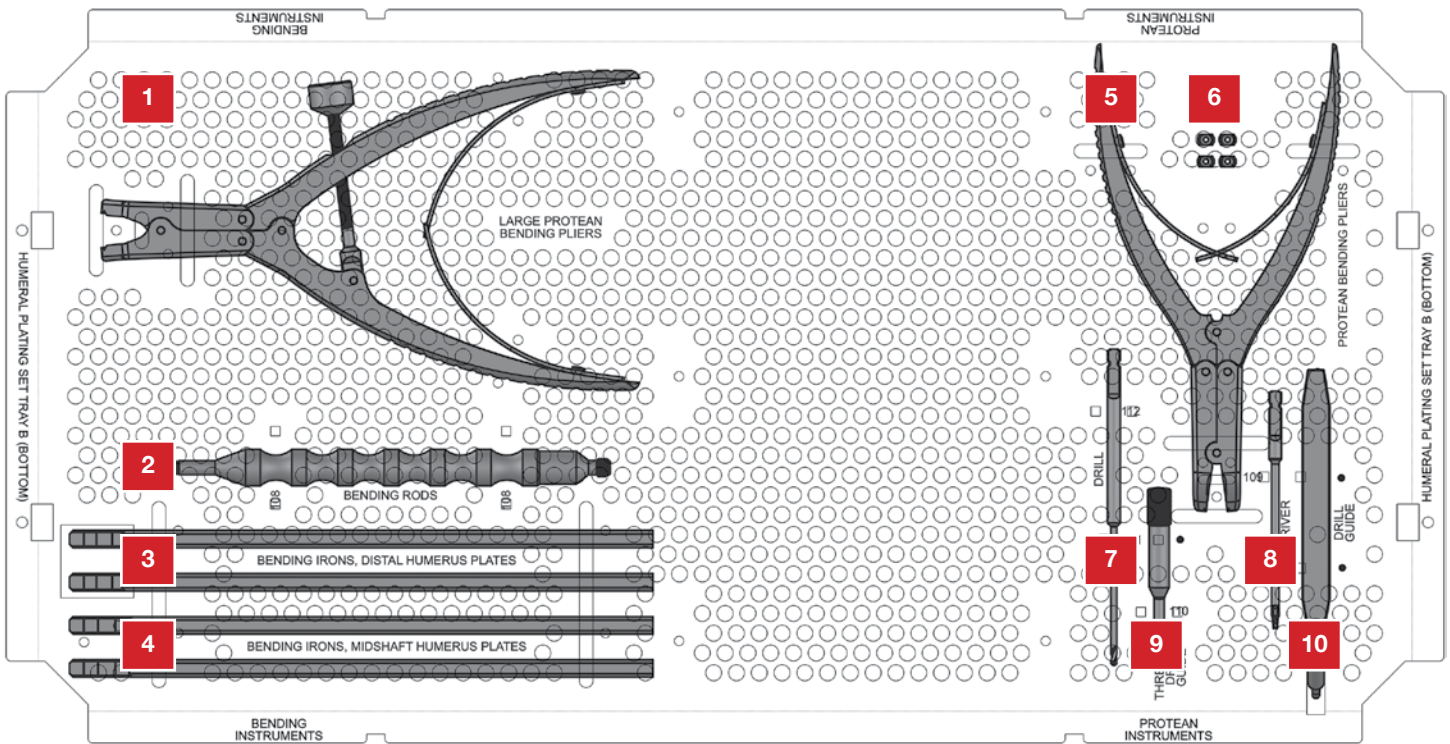

Loc#	Catalog#	Description
------	----------	-------------

1	PRT-BND-PLL	PROTEAN Plate Bending Pliers, Large
2	BND-ROD-DHP	Bending Rod, DHP
3	UNV-BND-35	Universal Bending Irons, 3.5mm
4	UNV-BND-45	Universal Bending Irons, 4.5mm
5	PRT-BND-PLR	PROTEAN Plate Bending Pliers
6	PDG-AIM-015	AIMing Guides, 1.5mm
7	DRLL-SSC-20040	Drill, 2.0mm x 40mm
8	DRVR-AOS-S20	Driver, Peg
9	TPDG-THD-DG20	Thread-in Drill Guide, 2.0mm
10	TPDG-SSD-20	Tissue Protector / Drill Guide, Single Sided, 2.0mm







# skeletal dynamics®

UNDERSTANDING THE UPPER EXTREMITY

